

**DPO3000 Series  
Digital Phosphor Oscilloscopes  
User Manual**

[www.tektronix.com](http://www.tektronix.com)  
071-2410-01

**Tektronix**

Copyright © Tektronix. All rights reserved. Licensed software products are owned by Tektronix or its subsidiaries or suppliers, and are protected by national copyright laws and international treaty provisions.

Tektronix products are covered by U.S. and foreign patents, issued and pending. Information in this publication supersedes that in all previously published material. Specifications and price change privileges reserved.

TEKTRONIX and TEK are registered trademarks of Tektronix, Inc.

e\*Scope, iView, OpenChoice, TekSecure, and TekVPI are registered trademarks of Tektronix, Inc.

Wave Inspector is a trademark of Tektronix, Inc.

## Contacting Tektronix

Tektronix, Inc.  
14200 SW Karl Braun Drive  
P.O. Box 500  
Beaverton, OR 97077  
USA

For product information, sales, service, and technical support:

- In North America, call 1-800-833-9200.
- Worldwide, visit [www.tektronix.com](http://www.tektronix.com) to find contacts in your area.

## Warranty 16

Tektronix warrants that the product will be free from defects in materials and workmanship for a period of three (3) years from the date of original purchase from an authorized Tektronix distributor. If the product proves defective during this warranty period, Tektronix, at its option, either will repair the defective product without charge for parts and labor, or will provide a replacement in exchange for the defective product. Batteries are excluded from this warranty. Parts, modules and replacement products used by Tektronix for warranty work may be new or reconditioned to like new performance. All replaced parts, modules and products become the property of Tektronix.

In order to obtain service under this warranty, Customer must notify Tektronix of the defect before the expiration of the warranty period and make suitable arrangements for the performance of service. Customer shall be responsible for packaging and shipping the defective product to the service center designated by Tektronix, shipping charges prepaid, and with a copy of customer proof of purchase. Tektronix shall pay for the return of the product to Customer if the shipment is to a location within the country in which the Tektronix service center is located. Customer shall be responsible for paying all shipping charges, duties, taxes, and any other charges for products returned to any other locations.

This warranty shall not apply to any defect, failure or damage caused by improper use or improper or inadequate maintenance and care. Tektronix shall not be obligated to furnish service under this warranty a) to repair damage resulting from attempts by personnel other than Tektronix representatives to install, repair or service the product; b) to repair damage resulting from improper use or connection to incompatible equipment; c) to repair any damage or malfunction caused by the use of non-Tektronix supplies; or d) to service a product that has been modified or integrated with other products when the effect of such modification or integration increases the time or difficulty of servicing the product.

THIS WARRANTY IS GIVEN BY TEKTRONIX WITH RESPECT TO THE PRODUCT IN LIEU OF ANY OTHER WARRANTIES, EXPRESS OR IMPLIED. TEKTRONIX AND ITS VENDORS DISCLAIM ANY IMPLIED WARRANTIES OF MERCHANTABILITY OR FITNESS FOR A PARTICULAR PURPOSE. TEKTRONIX' RESPONSIBILITY TO REPAIR OR REPLACE DEFECTIVE PRODUCTS IS THE SOLE AND EXCLUSIVE REMEDY PROVIDED TO THE CUSTOMER FOR BREACH OF THIS WARRANTY. TEKTRONIX AND ITS VENDORS WILL NOT BE LIABLE FOR ANY INDIRECT, SPECIAL, INCIDENTAL, OR CONSEQUENTIAL DAMAGES IRRESPECTIVE OF WHETHER TEKTRONIX OR THE VENDOR HAS ADVANCE NOTICE OF THE POSSIBILITY OF SUCH DAMAGES.



# Table of Contents

General Safety Summary .....	v
Environmental Considerations .....	viii
Preface.....	x
Key Features.....	x
Conventions Used in This Manual.....	xi
Installation .....	1
Before Installation.....	1
Operating Considerations .....	8
Connecting Probes .....	13
Securing the Oscilloscope .....	15
Powering On the Oscilloscope .....	16
Powering Off the Oscilloscope .....	18
Functional Check .....	19
Compensating a Passive Voltage Probe .....	22
Application Module Free Trial .....	24
Installing an Application Module.....	25
Changing the User Interface Language .....	26
Changing the Date and Time .....	28
Signal Path Compensation .....	30
Upgrading Firmware .....	33
Connecting Your Oscilloscope to a Computer .....	40

Connecting a USB Keyboard to Your Oscilloscope .....	48
Get Acquainted with the Instrument .....	49
Front-Panel Menus and Controls .....	49
Front-Panel Connectors .....	72
Side-Panel Connector .....	73
Rear-Panel Connectors .....	74
Acquire the Signal .....	76
Setting Up Analog Channels .....	76
Using the Default Setup .....	83
Using Autoset .....	84
Acquisition Concepts .....	85
How the Analog Acquisition Modes Work .....	88
Changing the Acquisition Mode, Record Length, and Delay Time .....	90
Using Roll Mode .....	93
Setting Up a Serial Bus .....	95
Trigger Setup .....	107
Triggering Concepts .....	107
Choosing a Trigger Type .....	114
Selecting Triggers .....	116
Triggering on Buses .....	121
Checking Trigger Settings .....	130
Using Sequence Trigger, A (Main) and B (Delayed) .....	131
Starting and Stopping an Acquisition .....	135

Display Waveform Data .....	136
Adding and Removing a Waveform .....	136
Setting the Display Style and Persistence .....	136
Setting Waveform Intensity .....	143
Scaling and Positioning a Waveform .....	144
Setting Input Parameters .....	146
Positioning and Labeling Bus Signals .....	151
Annotating the Screen .....	153
Analyze Waveform Data .....	155
Taking Automatic Measurements .....	155
Selecting Automatic Measurements .....	157
Customizing an Automatic Measurement .....	163
Taking Manual Measurements with Cursors .....	171
Using Math Waveforms .....	177
Using FFT .....	180
Using Advanced Math .....	184
Using Reference Waveforms .....	187
Using Wave Inspector to Manage Long Record Length Waveforms .....	189
Save and Recall Information .....	199
Saving a Screen Image .....	203
Saving and Recalling Waveform Data .....	204
Saving and Recalling Setups .....	209

Saving with One Button Push .....	212
Printing a Hard Copy .....	214
Erasing Oscilloscope Memory .....	223
Using Application Modules .....	226
Application Examples .....	227
Taking Simple Measurements .....	227
Analyzing Signal Detail .....	240
Triggering on a Video Signal .....	249
Capturing a Single-Shot Signal .....	255
Correlating Data with a TLA5000 Logic Analyzer .....	261
Tracking Down Bus Anomalies .....	263
Troubleshooting an RS-232 Bus .....	268
Appendix: Warranted Specifications, Safety Certifications, and Electromagnetic Compatibility .....	273
Index	



# General Safety Summary

Review the following safety precautions to avoid injury and prevent damage to this product or any products connected to it.

To avoid potential hazards, use this product only as specified.

*Only qualified personnel should perform service procedures.*

## To Avoid Fire or Personal Injury

**Use Proper Power Cord.** Use only the power cord specified for this product and certified for the country of use.

**Connect and Disconnect Properly.** Do not connect or disconnect probes or test leads while they are connected to a voltage source.

**Connect and Disconnect Properly.** De-energize the circuit under test before connecting or disconnecting the current probe.

**Ground the Product.** This product is grounded through the grounding conductor of the power cord. To avoid electric shock, the grounding conductor must be connected to earth ground. Before making connections to the input or output terminals of the product, ensure that the product is properly grounded.

**Observe All Terminal Ratings.** To avoid fire or shock hazard, observe all ratings and markings on the product. Consult the product manual for further ratings information before making connections to the product.

Connect the probe reference lead to earth ground only.

Do not apply a potential to any terminal, including the common terminal, that exceeds the maximum rating of that terminal.

**Power Disconnect.** The power cord disconnects the product from the power source. Do not block the power cord; it must remain accessible to the user at all times.

**Do Not Operate Without Covers.** Do not operate this product with covers or panels removed.

**Do Not Operate With Suspected Failures.** If you suspect that there is damage to this product, have it inspected by qualified service personnel.

**Avoid Exposed Circuitry.** Do not touch exposed connections and components when power is present.

**Do Not Operate in Wet/Damp Conditions.**

**Do Not Operate in an Explosive Atmosphere.**

**Keep Product Surfaces Clean and Dry.**

**Provide Proper Ventilation.** Refer to the manual's installation instructions for details on installing the product so it has proper ventilation.

## Terms in this Manual

These terms may appear in this manual:



**WARNING.** Warning statements identify conditions or practices that could result in injury or loss of life.

---



**CAUTION.** Caution statements identify conditions or practices that could result in damage to this product or other property.

---

## Symbols and Terms on the Product

These terms may appear on the product:

- DANGER indicates an injury hazard immediately accessible as you read the marking.
- WARNING indicates an injury hazard not immediately accessible as you read the marking.
- CAUTION indicates a hazard to property including the product.

The following symbol(s) may appear on the product:



## Environmental Considerations

This section provides information about the environmental impact of the product.

### Product End-of-Life Handling

Observe the following guidelines when recycling an instrument or component:

**Equipment Recycling.** Production of this equipment required the extraction and use of natural resources. The equipment may contain substances that could be harmful to the environment or human health if improperly handled at the product's end of life. In order to avoid release of such substances into the environment and to reduce the use of natural resources, we encourage you to recycle this product in an appropriate system that will ensure that most of the materials are reused or recycled appropriately.

The symbol shown below indicates that this product complies with the European Union's requirements according to Directive 2002/96/EC on waste electrical and electronic equipment (WEEE). For information about recycling options, check the Support/Service section of the Tektronix Web site ([www.tektronix.com](http://www.tektronix.com)).



**Mercury Notification.** This product uses an LCD backlight lamp that contains mercury. Disposal may be regulated due to environmental considerations. Please contact your local authorities or, within the United States, the Electronics Industries Alliance ([www.eiae.org](http://www.eiae.org)) for disposal or recycling information.

## **Restriction of Hazardous Substances**

This product has been classified as Monitoring and Control equipment, and is outside the scope of the 2002/95/EC RoHS Directive.

## Preface

This manual describes the installation and operation of the following oscilloscopes:

DPO3054

DPO3052

DPO3034

DPO3032

DPO3014

DPO3012

## Key Features

DPO3000 series instruments can help you verify, debug, and characterize electronic designs. Key features include:

- 500 MHz, 300 MHz, and 100 MHz bandwidths
- 2 and 4 channel models
- Sample rates up to 2.5 GS/s on all analog channels
- 5 M points record length on all channels
- 50,000 waveforms/second display rate
- I<sup>2</sup>C, SPI, CAN, LIN, RS-232, RS-422, RS-485, and UART bus triggering and analysis (with the appropriate application module and model oscilloscope)
- Wave Inspector controls for managing long record lengths, with zoom and pan, play and pause, search and mark
- 229 mm (9 inch), with 800 x 480 resolution, WVGA color display
- Small and lightweight, at 127 mm (5 inches) deep and 4.1 kg (9 pounds)
- USB available for quick and easy storage

- Built-in Ethernet port
- USB 2.0 device port for direct PC control of the oscilloscope using USBTMC protocol
- OpenChoice documentation and analysis software
- NI LabVIEW SignalExpress™ Tektronix Edition productivity and analysis software
- Remote viewing and control with e\*Scope
- Remote control with VISA connectivity
- TekVPI Versatile Probe Interface supports active, differential, and current probes for automatic scaling and units

## Conventions Used in This Manual

The following icons are used throughout this manual.

Sequence Step



Front panel power



Connect power

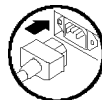

Network

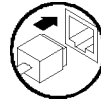

USB

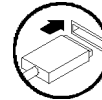





# Installation

## Before Installation

Unpack the oscilloscope and check that you received all items listed as standard accessories. The following pages list recommended accessories and probes, instrument options, and upgrades. Check the Tektronix Web site ([www.tektronix.com](http://www.tektronix.com)) for the most current information.

## Standard Accessories

Accessory	Description	Tektronix part number
<i>DPO3000 Series Oscilloscopes User Manual</i>	English (Option L0)	071-2410-XX
	French (Option L1)	071-2411-XX
	Italian (Option L2)	071-2412-XX
	German (Option L3)	071-2413-XX
	Spanish (Option L4)	071-2414-XX
	Japanese (Option L5)	071-2415-XX
	Portuguese (Option L6)	071-2416-XX
	Simple Chinese (Option L7)	071-2417-XX
	Traditional Chinese (Option L8)	071-2418-XX
	Korean (Option L9)	071-2419-XX
	Russian (Option L10)	071-2420-XX
<i>DPO3000 Series Oscilloscopes Documentation Browser CD</i>	Electronic versions of documents, including the Programmer Manual and the Technical Reference	063-4104-XX
<i>NI LabVIEW SignalExpress Tektronix Edition and Tektronix OpenChoice Desktop CD</i>	Productivity, analysis, and documentation software	063-3967-XX
Calibration certificate documenting traceability to national metrology institute(s), and ISO9001 quality system registration		—

**Standard Accessories (cont.)**

<b>Accessory</b>	<b>Description</b>	<b>Tektronix part number</b>
Front Panel Overlay	French (Option L1)	335-1917-00
	Italian (Option L2)	335-1918-00
	German (Option L3)	335-1919-00
	Spanish (Option L4)	335-1920-00
	Japanese (Option L5)	335-1921-00
	Portuguese (Option L6)	335-1922-00
	Simplified Chinese (Option L7)	335-1923-00
	Traditional Chinese (option L8)	335-1924-00
	Korean (Option L9)	335-1925-00
	Russian (Option L10)	335-1926-00
For DPO3000 series: Probes	One, 500 MHz, 10X passive probe per channel	P6139A
Front Cover	Hard plastic cover to help protect the instrument	200-2524-00

**Standard Accessories (cont.)**

<b>Accessory</b>	<b>Description</b>	<b>Tektronix part number</b>
Power Cord	North America (Option A0)	161-0348-00
	Universal Euro (Option A1)	161-0343-00
	United Kingdom (Option A2)	161-0344-00
	Australia (Option A3)	161-0346-00
	Switzerland (Option A5)	161-0347-00
	Japan (Option A6)	161-0342-00
	China (Option A10)	161-0341-00
	India (Option A11)	161-0349-00
	No power cord or AC adapter (Option A99)	—

**Optional Accessories**

<b>Accessory</b>	<b>Description</b>	<b>Tektronix part number</b>
DPO3EMBD	The embedded serial triggering and analysis module enables triggering on packet level information on I <sup>2</sup> C and SPI serial buses, as well as digital views of the signal, bus views, bus decoding, search tools, and packet decode tables with timestamp information	DPO3EMBD
DPO3AUTO	The automotive serial triggering and analysis module enables triggering on packet level information on CAN and LIN serial buses, as well as digital views of the signal, bus views, bus decoding, search tools, and packet decode tables with timestamp information	DPO3AUTO
DPO3COMP	The computer triggering and analysis module enables triggering on RS-232, RS-422, RS-485 and UART serial buses, search tools, bus views, bus decoding in hex, binary, and ASCII, and decode tables with timestamp information	DPO3COMP
DPO3VID	The extended video module enables triggering on a variety of standard HDTV signals, as well as on custom (non-standard) bilevel and trilevel video signals with 3 to 4,000 lines.	DPO3VID
TPA-BNC	TekVPI to TekProbe II BNC Adapter	TPA-BNC

**Optional Accessories (cont.)**

<b>Accessory</b>	<b>Description</b>	<b>Tektronix part number</b>
TEK-USB-488 Adapter	GPIB to USB Adapter	TEK-USB-488
Getting Started with OpenChoice Solutions Manual with CD	Describes ways to develop host-computer software applications that work with your oscilloscope	020-2513-XX
Rackmount kit	Adds rackmount brackets	RMD3000
Soft transit case	Case for carrying instrument	ACD4000
Hard transit case	Traveling case, which requires use of the soft transit case (ACD4000)	HCTEK4321
USB flash drive	Extra storage	119-7276-00
DPO3000 Series Oscilloscopes Programmer Manual	Describes commands for remote control of the oscilloscope. Available electronically on the Documentation Browser CD or for download from <a href="http://www.tektronix.com/manuals">www.tektronix.com/manuals</a>	071-2421-XX
DPO3000 Series Oscilloscopes Technical Reference Manual	Describes the oscilloscope specifications and performance verification procedure. Available electronically on the Documentation Browser CD or for download from <a href="http://www.tektronix.com/manuals">www.tektronix.com/manuals</a>	071-2423-XX

**Optional Accessories (cont.)**

<b>Accessory</b>	<b>Description</b>	<b>Tektronix part number</b>
DPO3000 Series Oscilloscopes Service manual	Service information on DPO3000 oscilloscopes	071-2422-XX
DPO3000 Series Oscilloscopes Module Installation	Manual	071-2524-XX

The DPO3000 series oscilloscopes work with multiple optional probes. (See page 13, *Connecting Probes*.) Check the Tektronix Web site ([www.tektronix.com](http://www.tektronix.com)) for the most current information.

## Operating Considerations

### DPO3000 Series Oscilloscopes

Input Voltage: 100 V to 240 V  $\pm$  10%

Input Power Frequency:  
50/60 Hz at 100 V to 240 V  
400 Hz  $\pm$  10% at 115 V

Power Consumption: 120 W maximum

Weight: 4.2 kg (9.2 lbs), standalone instrument

Height, including feet but not handle:  
203.2 mm (8 in)

Width, 416.6 mm (16.4 in)

Depth, 147.4 mm (5.8 in)

Clearance: 51 mm (2 in)

Temperature:

Operating: +0 °C to +50 °C

Nonoperating: -40 °C to +71 °C



DPO3000 series



**Humidity:**

Operating: 5% to 95% relative humidity (RH) at up to +30 °C

Operating: 5% to 45% relative humidity (RH) above +30 °C up to +50 °C, non-condensing, and as limited by a Maximum Wet-Bulb Temperature of +38 °C (derates relative humidity to 45 % RH at +50 °C)

Non-operating: 5% to 95% Relative Humidity (RH) at up to +30 °C

Non-operating: 5% to 45% Relative Humidity (RH) above +30 °C up to +50 °C, non-condensing, and as limited by a Maximum Wet-Bulb Temperature of +38 °C (derates relative humidity to 27% RH at 60 C)

**Altitude:**

Operating: 3,000 m (9,843 ft)

Nonoperating Altitude: 12,000 m (39,370 ft)

**Random Vibration:**

Operating: 0.31  $G_{RMS}$ , 5 – 500 Hz, 10 minutes per axis, 3 axes (30 minutes total)

Non-operating: 2.46  $G_{RMS}$ , 5 – 500 Hz, 10 minutes per axis, 3 axes (30 minutes total)

Pollution Degree: 2, Indoor use only

**Acquisition System: 1 M $\Omega$** 

The maximum input voltage: At front panel connector, 300  $V_{RMS}$ , Installation Category II; for measurements performed on circuits directly connected to the low-voltage installation.

**Acquisition System: 50  $\Omega$  and 75  $\Omega$** 

The maximum input voltage: 5  $V_{RMS}$  with a peak at  $\pm 20$ . For Installation Category I measurements. Not for connection to Installation Category II, III, or IV circuits.

Aux In: 1 M $\Omega$

The maximum input voltage: At the front-panel connector, 300 V<sub>RMS</sub>, Installation Category II; for measurements performed on circuits directly connected to the low-voltage installation.



**CAUTION.** *To ensure proper cooling, keep the sides and rear of the instrument clear of obstructions.*

Total Probe Power:

If the total probe power requirements exceed the available power from the oscilloscope, connect the external AC adapter (Tektronix part number 119-7465-XX) to the rear-panel Probe Power connector.

Maximum Probe Power Available Per Channel (3 or 5 TekVPI Interfaces):

5 V  $\pm$  5%, 50 mA max., 250 mW max.

12 V  $\pm$  10%, 2 A max., 24 W max.

## P6139A Passive Probe

### Input Voltage:

400 V<sub>RMS</sub> or 400 V DC; CAT I (2,500 V<sub>pk</sub> transient)

300 V<sub>RMS</sub> or 300 V DC; CAT II (2,500 V<sub>pk</sub> transient)

150 V<sub>RMS</sub> or 150 V DC; CAT III (2,500 V<sub>pk</sub> transient)

For steady-state, sinusoidal waveforms, derate at 20 dB/decade above 2.5 MHz to 50 V<sub>RMS</sub> at 20 MHz and above.

### Output Voltage (terminated into 1 M $\Omega$ ):

40 V<sub>RMS</sub> or 40 V DC; CAT I (2,500 V<sub>pk</sub> impulse)

30 V<sub>RMS</sub> or 30 V DC; CAT I (250 V<sub>pk</sub> impulse)

15 V<sub>RMS</sub> or 15 V DC; CAT I (250 V<sub>pk</sub> impulse)

### Temperature:

Operating: -15 °C to +65 °C ( +5 °F to +149 °F)

Nonoperating: -62 °C to +85 °C ( -80 °F to +185 °F)

Altitude:  $\leq$  2,000 meters

Pollution Degree: 2, Indoor use only

Humidity:

Operating: High: 40 °C to 50 °C, 10% to 60% RH

Operating: Low: 0 °C to 40 °C, 10 to 90% RH

## Cleaning

Inspect the oscilloscope and probes as often as operating conditions require. To clean the exterior surface, perform the following steps:

1. Remove loose dust on the outside of the oscilloscope and probes with a lint-free cloth. Use care to avoid scratching the clear glass display filter.
2. Use a soft cloth dampened with water to clean the oscilloscope. Use an aqueous solution of 75% isopropyl alcohol for more efficient cleaning.



**CAUTION.** *To avoid damage to the surface of the oscilloscope or probes, do not use any abrasive or chemical cleaning agents.*

---

## Connecting Probes

The oscilloscope supports probes with the following:

1. Tektronix Versatile Probe Interface (TekVPI)

These probes support two-way communication with the oscilloscope through on-screen menus and remotely through programmable support. The remote control is useful in applications like ATE where you want the system to preset probe parameters.

2. TPA-BNC Adapter

The TPA-BNC Adapter allows you to use TEKPROBE II probe capabilities, such as providing probe power, and passing scaling and unit information to the oscilloscope.

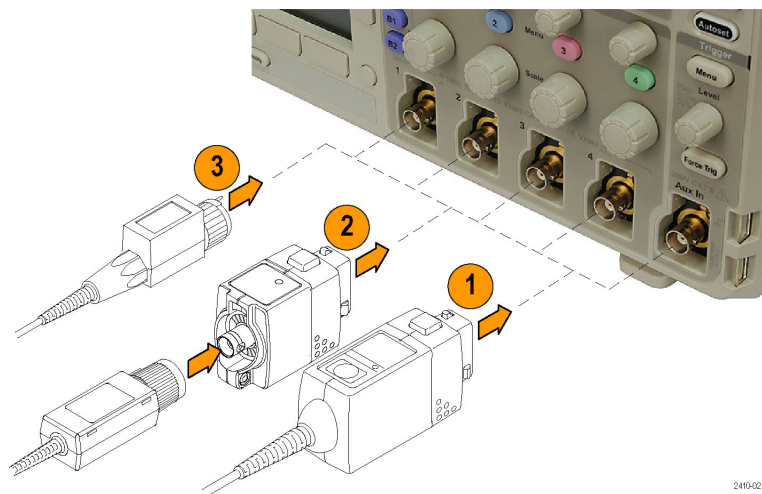

2410-021

### 3. Plain BNC Interfaces

Some of these use TEKPROBE capabilities to pass the waveform signal and scaling to the oscilloscope. Some only pass the signal and there is no other communication.

For more information on the many probes available for use with DPO3000 series oscilloscopes, refer to [www.tektronix.com](http://www.tektronix.com).

## Securing the Oscilloscope

1. Use a standard laptop computer style security lock to secure your oscilloscope to your location.

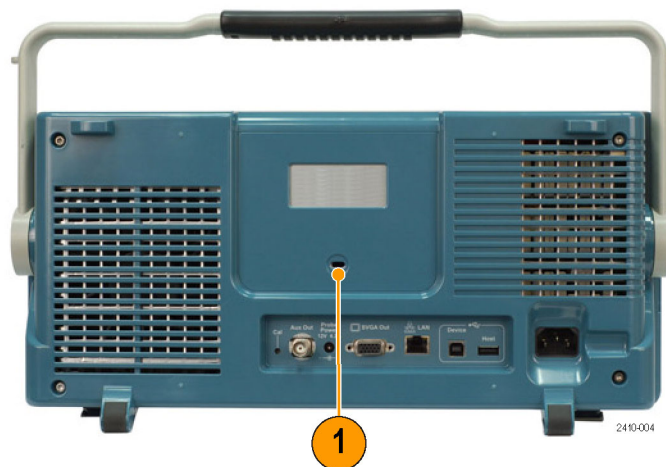

## Powering On the Oscilloscope

### Ground the Oscilloscope and Yourself

Before pushing the power switch, connect the oscilloscope to an electrically neutral reference point, such as earth ground. Do this by plugging the three-pronged power cord into an outlet grounded to earth ground.

Grounding the oscilloscope is necessary for safety and to take accurate measurements. The oscilloscope needs to share the same ground as any circuits that you are testing.

If you are working with static sensitive components, ground yourself. Static electricity that builds up on your body can damage static-sensitive components. Wearing a grounding strap safely sends static charges on your body to earth ground.

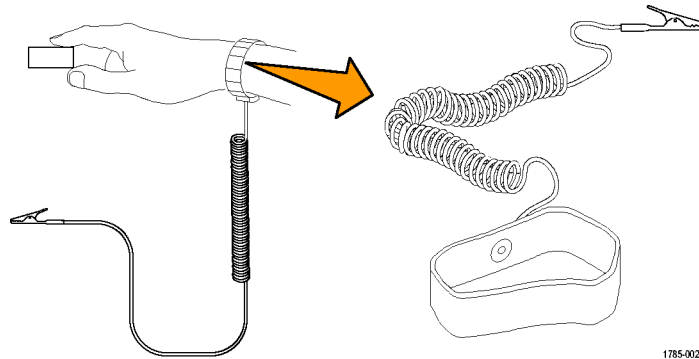



To connect the power cord and power on the oscilloscope:

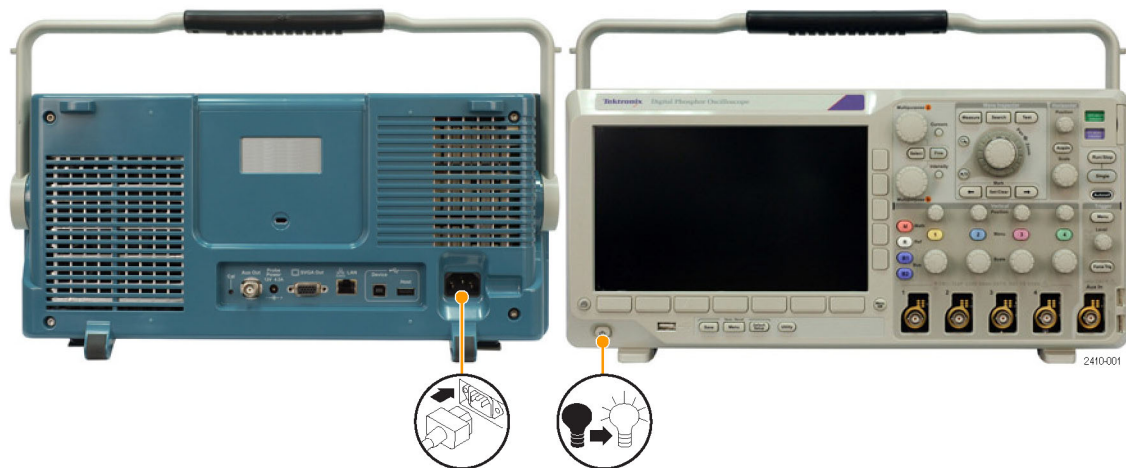

## Powering Off the Oscilloscope

To power off the oscilloscope and remove the power cord:



## Functional Check

Perform this quick functional check to verify that your oscilloscope is operating correctly.

1. Connect the oscilloscope power cable as described in *Powering On the Oscilloscope*. (See page 16.)
2. Power on the oscilloscope.



3. Connect the P6139A probe tip and reference lead to the **PROBE COMP** connectors on the oscilloscope.



4. Push **Default Setup**.



5. Push **Autoset**. The screen should now display a square wave, approximately 2.5 V at 1 kHz.

**NOTE.** For best performance, it is recommended that you set the Vertical scale to 500 mV.

If the signal appears but is misshapen, perform the procedures for compensating the probe. (See page 22, *Compensating a Passive Voltage Probe*.)

If no signal appears, rerun the procedure. If this does not remedy the situation, have the instrument serviced by qualified service personnel.

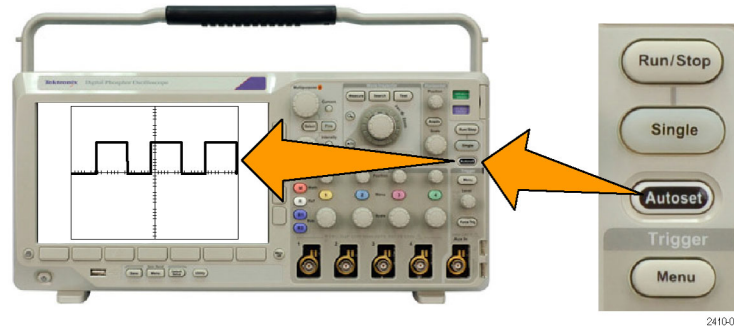

## Compensating a Passive Voltage Probe

Whenever you attach a passive voltage probe for the first time to any input channel, compensate the probe to match it to the corresponding oscilloscope input channel.

To properly compensate your passive probe:

1. Follow the steps for the functional check. (See page 19, *Functional Check*.)
2. Check the shape of the displayed waveform to determine if your probe is properly compensated.



Properly compensated



Under compensated



Over compensated

3. If necessary, adjust your probe.  
Repeat as needed.

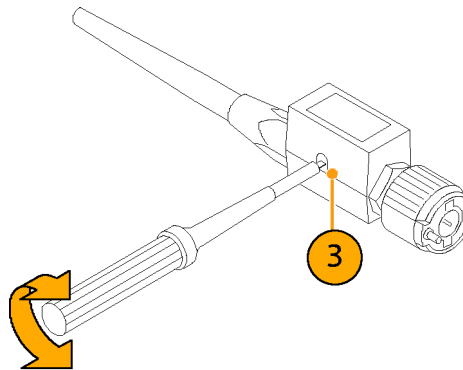

1785-140

## Quick Tips

Use the shortest possible ground lead and signal path to minimize probe-induced ringing and distortion on the measured signal.



Signal with a short ground lead



Signal with a long ground lead

## Application Module Free Trial

A 30-day free trial is available for all application modules not installed in your oscilloscope. The trial period begins when you power on the oscilloscope for the first time.

After 30 days, you must purchase the module if you want to continue using the application. To see the date when your free trial period expires, push the front panel **Utility** button, push the lower-bezel **Utility Page** button, use multipurpose knob **a** to select **Config**, and push the lower-bezel **About** button.



## Installing an Application Module



---

**CAUTION.** To avoid damage to the oscilloscope or application module, observe ESD (electrostatic discharge) precautions. (See page 16, *Powering On the Oscilloscope.*)

Turn off the oscilloscope power while removing or adding an application module.

(See page 18, *Powering Off the Oscilloscope.*)

---

Optional application module packages extend the capability of your oscilloscope. You can install up to four application modules at one time. Application modules go into the two slots with windows in the upper right corner of the front panel. Two additional slots are directly behind the two that you can see. To use these slots, install the module with the label facing away from you.

Refer to the *Tektronix 3000 Series Oscilloscopes Application Module Installation Instructions* that came with your application module for instructions on installing and testing an application module.

---

**NOTE.** If you remove an application module, the features provided by the application module become unavailable. To restore the features, turn off the oscilloscope power, reinstall the module and turn on the oscilloscope power.

---

## Changing the User Interface Language

To change the language of the oscilloscope user interface, and to change the front-panel button labels through the use of an overlay:

1. Push **Utility**.



2. Push **Utility Page**.



3. Turn multipurpose knob **a** and select **Config**.

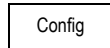

4. Push **Language** from the resulting lower-bezel menu.

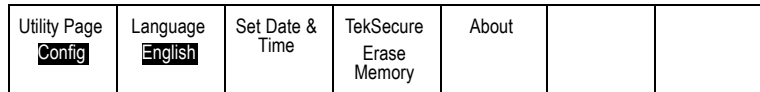

5. Turn multipurpose knob **a** and select the desired language. Choose among: English, French, German, Italian, Spanish, Brazilian Portuguese, Russian, Japanese, Korean, Simplified Chinese, and Traditional Chinese.
6. If you choose to use English, be sure that the plastic front-panel overlay is removed.  
If you choose a language other than English, place the plastic overlay for the language that you desire over the front panel to display labels in that language.

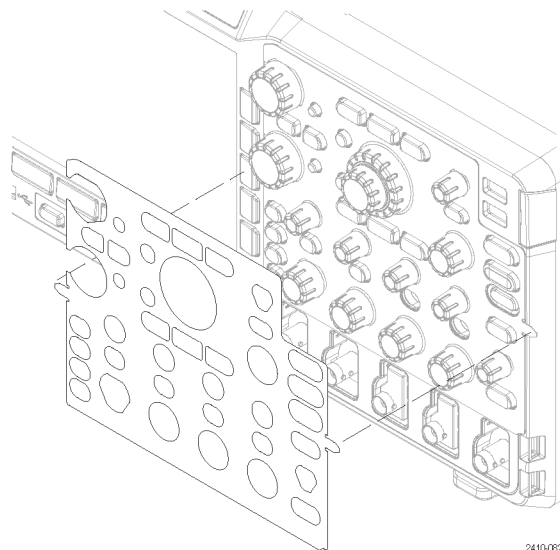

2410-082

## Changing the Date and Time

To set the internal clock with the current date and time:

1. Push **Utility**.



2. Push **Utility Page**.

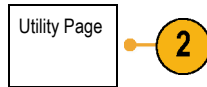

3. Turn multipurpose knob **a** and select **Config**.

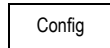

4. Push **Set Date & Time**.

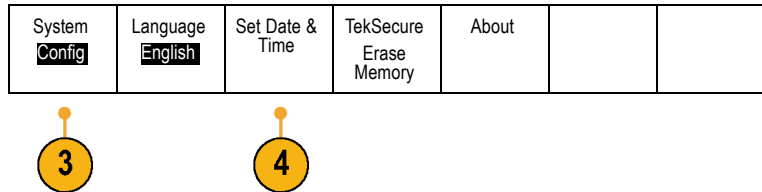

- 5. Push the side-bezel buttons and turn both multipurpose knobs (a and b) to set the time and date values.

Set Date & Time
Display Date & Time
<input checked="" type="checkbox"/> On Off
Hour 4
Minute 1
Month May
Day 3
Year 2007
OK Enter Date & Time



- 6. Push **OK Enter Date & Time**.

## Signal Path Compensation

Signal Path Compensation (SPC) corrects for DC inaccuracies caused by temperature variations and/or long-term drift. Run the compensation whenever the ambient temperature has changed by more than 10 °C or once a week if you use vertical settings of 5 mV/division or less. Failure to do so may result in the instrument not meeting warranted performance levels at those volts/div settings.

To compensate the signal path:

1. Warm up the oscilloscope for at least 20 minutes. Remove all input signals (probes and cables) from channel inputs. Input signals with AC components adversely affect SPC.



2. Push **Utility**.



3. Push **Utility Page**.

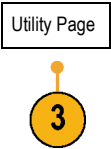

4. Turn multipurpose knob **a** and select **Calibration**.

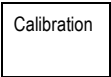

5. Push **Signal Path** from the lower-bezel menu.

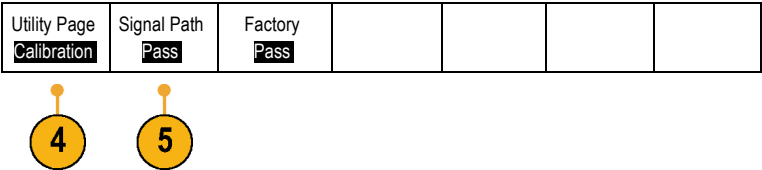

6. Push **OK Compensate Signal Paths** from the resulting side-bezel menu.



The calibration will take approximately 10 minutes to complete.

7. After calibration, verify that the status indicator on the lower-bezel menu displays **Pass**.

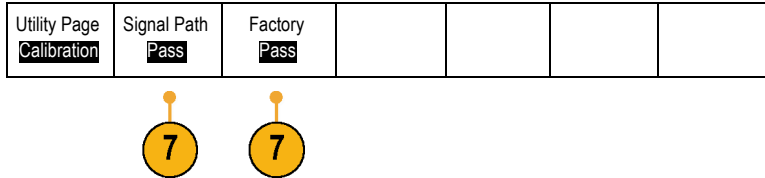

If it does not, then recalibrate the instrument or have the instrument serviced by qualified service personnel.

Service personnel use the factory calibration functions to calibrate the internal voltage references of the oscilloscope using external sources. Refer to your Tektronix field office or representative for assistance with factory calibration.

---

**NOTE.** *Signal Path Compensation does not include calibration to the probe tip. (See page 22, Compensating a Passive Voltage Probe.)*

---



## Upgrading Firmware

To upgrade the firmware of the oscilloscope:

1. Open up a Web browser and go to [www.tektronix.com/software](http://www.tektronix.com/software). Proceed to the software finder. Download the latest firmware for your oscilloscope on your PC.

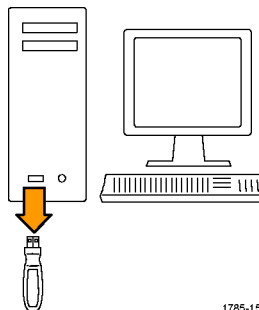

1785-157

Unzip the files and copy the firmware.img file into the root folder of a USB flash drive.

2. Power off your oscilloscope.



3. Insert the USB flash drive into the front-panel USB port on your oscilloscope.



4. Power on the oscilloscope. The instrument automatically recognizes the replacement firmware and installs it.

If the instrument does not install the firmware, rerun the procedure. If the problem continues, try a different model of USB flash drive. Finally, if needed, contact qualified service personnel.

**NOTE.** Do not power off the oscilloscope or remove the USB flash drive until the oscilloscope finishes installing the firmware.



5. Power off the oscilloscope and remove the USB flash drive.



6. Power on the oscilloscope.



7. Push **Utility**.



8. Push **Utility Page**.

Utility Page



9. Turn multipurpose knob **a** and select **Config**.

Config

10. Push **About**. The oscilloscope displays the firmware version number.

Utility Page Config	Language English	Set Date & Time	TekSecure Erase Memory	About		
------------------------	---------------------	--------------------	------------------------------	-------	--	--

11. Confirm that the version number matches that of the new firmware.



## Connecting Your Oscilloscope to a Computer

You may want to document your work for future reference. Instead of saving screen images and waveform data to a USB flash drive, and then generating a report later, you may want to send the image or waveform data directly to a remote PC for analysis. You may also want to control an oscilloscope at a remote location from your computer. (See page 203, *Saving a Screen Image*.) (See page 204, *Saving and Recalling Waveform Data*.)

Two ways to connect your oscilloscope to a computer are through the VISA drivers and the e\*Scope Web-enabled tools. Use VISA to communicate with your oscilloscope from your computer through a software application. Use e\*Scope to communicate with your oscilloscope through a Web browser.

### Using VISA

VISA lets you use your MS-Windows computer to acquire data from your oscilloscope for use in an analysis package that runs on your PC, such as Microsoft Excel, National Instruments LabVIEW, or a program of your own creation. You can use a common communications connection, such as USB, Ethernet, or GPIB, to connect the computer to the oscilloscope.

To set up VISA communications between your oscilloscope and a computer:

1. Load the VISA drivers on your computer.  
You will find the drivers on the appropriate CD that comes with your oscilloscope or at the Tektronix software finder Web page ([www.tektronix.com/software](http://www.tektronix.com/software)).



- 2. Connect the oscilloscope to your computer with the appropriate USB or Ethernet cable.

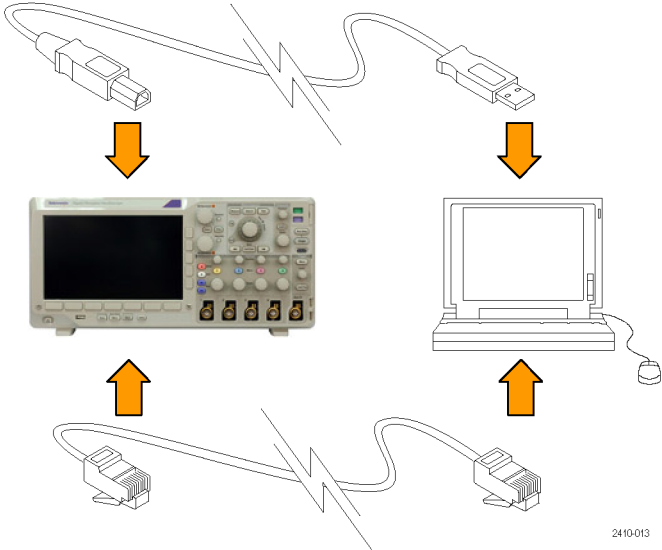

2410-013

To communicate between the oscilloscope and a GPIB system, connect the oscilloscope to the TEK-USB-488 GPIB-to-USB Adapter with a USB cable. Then connect the adapter to your GPIB system with a GPIB cable. Cycle the power on the oscilloscope.

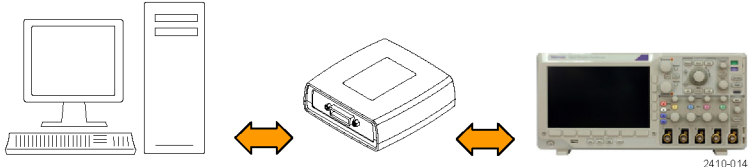

2410-014

3. Push **Utility**.



4. Push **Utility Page**.

Utility Page



5. Turn multipurpose knob **a** and select **I/O**.

I/O

6. If you are using USB, the system sets itself up automatically for you, if USB is enabled.  
Check **USB** on the lower-bezel menu to be sure that USB is enabled. If it is not enabled, push **USB**. Then push **Enabled** on the side-bezel menu.

Utility Page I/O	USB Enabled	Ethernet Network Settings	GPIB 1			
---------------------	----------------	---------------------------	-----------	--	--	--



7. To use Ethernet, push **Ethernet Network Settings**.

On the side-bezel menu, if you are on a DHCP Ethernet network and using a through cable, set DHCP to **On**. If you are using a cross-over cable, set it to **Off** and set a hard coded TCP/IP address.

Change Instrument Settings
DHCP/BOOTP <input checked="" type="radio"/> On <input type="radio"/> Off
Test Connection

8. If you are using GPIB, push **GPIB**. Enter the GPIB address on the side-bezel menu, using multipurpose knob **a**.

This will set the GPIB address on an attached TEK-USB-488 Adapter.

Talk/Listen Address <input checked="" type="radio"/> a <input type="radio"/> 1
---



9. Run your application software on your computer.



## Quick Tips

- The CD that is shipped with your oscilloscope includes a variety of Windows-based software tools designed to ensure efficient connectivity between your oscilloscope and your computer. There are toolbars that speed connectivity with Microsoft Excel and Word. There is also a standalone acquisition program called the OpenChoice Desktop.
- The rear-panel USB 2.0 device port is the correct USB port for computer connectivity. Use the rear- and front-panel USB 2.0 host ports to connect your oscilloscope to USB flash drives and printers.

USB Host port

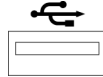

USB Device port



## Using e\*Scope

e\*Scope lets you access any Internet-connected DPO3000 series oscilloscope from a browser on your workstation, PC, or laptop computer. No matter where you are, your oscilloscope is as close as the nearest browser.

To set up e\*Scope communications between your oscilloscope and a Web browser running on a remote computer:

1. Connect the oscilloscope to your computer network with the appropriate Ethernet cable.  
If you are connecting directly to your computer, you need a Crossover Ethernet Cable. If you are connecting to a network or a hub you need a Straight Through Ethernet Cable.

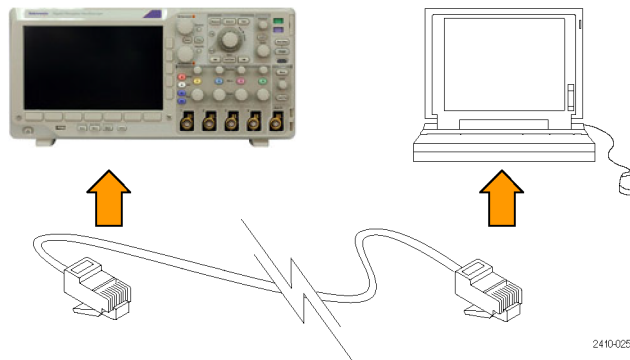

2. Push **Utility**.



3. Push **Utility Page**.

Utility Page



4. Turn multipurpose knob **a** and select **I/O**.

I/O

5. Push **Ethernet Network Settings**.

Utility Page I/O	USB Enabled	Ethernet Network Settings 1			
---------------------	----------------	--------------------------------------	--	--	--



6. On the side-bezel menu, if you are on a DHCP Ethernet network and using dynamic addressing, set DHCP to **On**. If you are using static addressing, set it to **Off**.

Push **Change Instrument Settings**. If you are using DHCP, note the Ethernet address and instrument name. If you are using Static addressing, enter the Ethernet address you will be using.

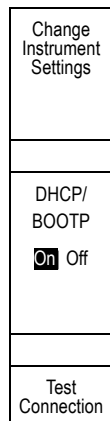

**NOTE.** Depending on the type and speed of network to which your DPO3000 series oscilloscope is connected, you may not see the DHCP/BOOTP field update instantaneously after pressing the DHCP/BOOTP button. It may take a few seconds to update.

7. Start your browser on your remote computer.  
In the browser address line, enter the IP address or, if DHCP is set to **On** in the oscilloscope, simply enter the instrument name.
8. You should now see the e\*Scope screen showing the oscilloscope display, on your Web browser.  
If e\*Scope does not work, rerun the procedure.  
If it still does not work, contact qualified service personnel.

## Connecting a USB Keyboard to Your Oscilloscope

You can connect a US-style USB keyboard to a USB Host port on the rear or front panel of the oscilloscope. The oscilloscope will detect the keyboard, even if it is plugged in while the oscilloscope is powered on.

You can use the keyboard to quickly create names or labels. You can bring up the Label menu through the lower-bezel label button of the Channel or Bus menus. Use the arrow keys on the keyboard to move the insertion point, and then type in a name or label. Labeling channels and buses makes the information on the screen easier to identify.



# Get Acquainted with the Instrument

## Front-Panel Menus and Controls

The front panel has buttons and controls for the functions that you use most often. Use the menu buttons to access more specialized functions.

## Using the Menu System

To use the menu system:

1. Push a front-panel menu button to display the menu that you want to use.



2410-026

2. Push a lower-bezel button to select a menu item. If a pop-out menu appears, turn multipurpose knob **a** to select the desired choice. If a pop-up menu appears, press the button again to select the desired choice.

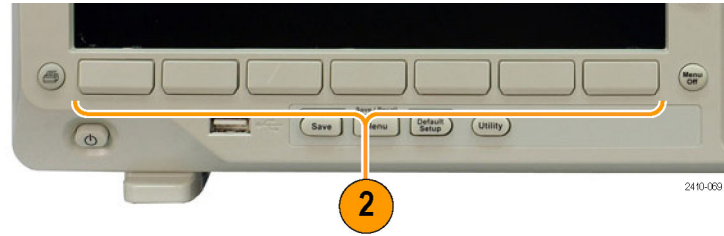

3. Push a side-bezel button to choose a side-bezel menu item.  
If the menu item contains more than one choice, push the side-bezel button repeatedly to cycle through the choices.  
If a pop-out menu appears, turn multipurpose knob **a** to select the desired choice.



4. To remove a side-bezel menu, push the lower-bezel button again or push **Menu Off**.



5. Certain menu choices require you to set a numeric value to complete the setup. Use the upper and lower multipurpose knobs **a** and **b** to adjust values.
6. Push **Fine** to turn off or on the ability to make smaller adjustments.



## Using the Menu Buttons

Use the menu buttons to perform many functions in the oscilloscope.

1. **Measure.** Push to perform automated measurements on waveforms or to configure cursors.
2. **Search.** Push to search through an acquisition for user-defined events/criteria.
3. **Test.** Push to activate advanced or application-specific testing features.
4. **Acquire.** Push to set the acquisition mode and adjust the record length.
5. **Autoset.** Push to perform an automatic setup of oscilloscope settings.
6. **Trigger Menu.** Push to specify trigger settings.

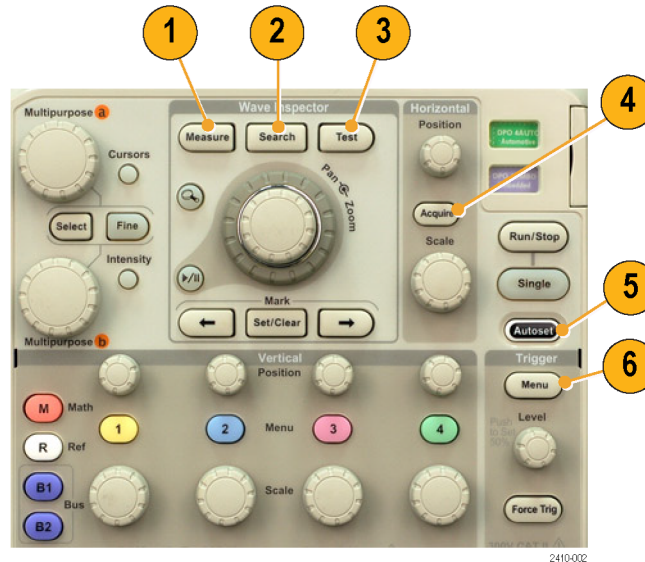

7. **Utility.** Push to activate the system utility functions, such as selecting a language or setting the date/time.

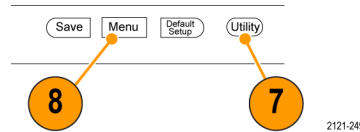

8. **Save / Recall Menu.** Push to save and recall setups, waveforms, and screen images to internal memory or a USB flash drive.

9. **Channel 1,2,3, or 4 Menu.** Push to set vertical parameters for input waveforms and to display or remove the corresponding waveform from the display.



- 10. B1 or B2.** Push to define and display a bus if you have the appropriate module application keys. The DPO3AUTO module supports CAN and LIN buses. The DPO3EMBD module supports I<sup>2</sup>C and SPI. The DPO3COMP module supports RS-232, RS-422, RS-485, and UART buses.

Also, push the **B1** or **B2** button to display or remove the corresponding bus from the display.

- 11. R.** Push to manage reference waveforms, including the display or removal of each reference waveform from the display.

- 12. M.** Push to manage the math waveform, including the display or removal of the math waveform from the display.



2410-033

## Using Other Controls

These buttons and knobs control waveforms, cursors, and other data input.



1. Turn the upper multipurpose knob **a**, when activated, to move a cursor, to set a numerical parameter value for a menu item, or to select from a pop-out list of choices. Push the **Fine** button to toggle between coarse and fine adjustment. Screen icons tell you when **a** or **b** are active.

2. **Cursors.** Push once to activate the two vertical cursors. Push again to turn on the two vertical and two horizontal cursors. Push again to turn off all cursors. When the cursors are on, you can turn the multipurpose knobs to control their position.

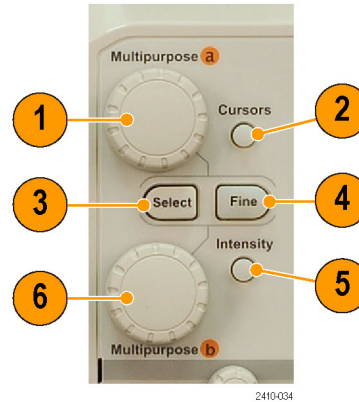

- 3. Select.** Push to activate special functions.  
For example, when using the two vertical cursors (and no horizontal ones are visible), you can push this button to link or unlink the cursors. When the two vertical and two horizontal cursors are both visible, you can push this button to make either the vertical cursors or the horizontal cursors active.
- 4. Fine.** Push to toggle between making coarse and fine adjustments with the vertical and horizontal position knobs, the trigger level knob, and many operations of multipurpose knobs **a** and **b**.
- 5. Waveform Intensity.** Push to enable multipurpose knob **a** to control waveform display intensity and knob **b** to control graticule intensity.

6. Turn the lower multipurpose knob **b**, when activated, to move a cursor or set a numerical parameter value for a menu item. Push **Fine** to make adjustments more slowly.
7. **Zoom** button. Push to activate zoom mode.
8. **Pan** (outer knob). Turn to scroll the zoom window through the acquired waveform.
9. **Zoom** (inner knob). Turn to control the zoom factor. Turning it clockwise zooms in further. Turning it counterclockwise zooms out.
10. **Play-pause** button. Push to start or stop the automatic panning of a waveform. Control the speed and direction with the pan knob.

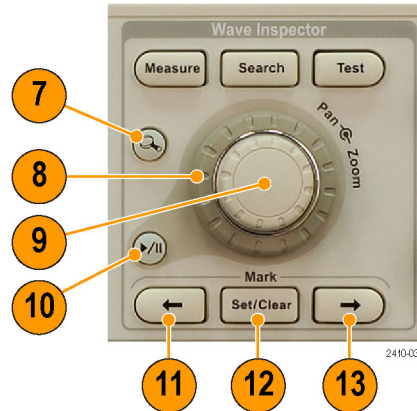

11. ← **Prev.** Push to jump to the previous waveform mark.
12. **Set/Clear Mark.** Push to establish or delete a waveform mark.
13. → **Next.** Push to jump to the next waveform mark.
14. **Horizontal Position.** Turn to adjust the trigger point location relative to the acquired waveforms. Push **Fine** to make smaller adjustments.
15. **Horizontal Scale.** Turn to adjust the horizontal scale (time/division).

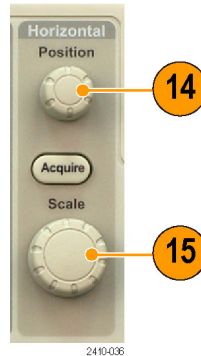

16. **Run/Stop.** Push to start or stop acquisitions.
17. **Single.** Push to make a single acquisition.
18. **Autoset.** Push to automatically set the vertical, horizontal, and trigger controls for a usable, stable display.
19. **Trigger Level.** Turn to adjust the trigger level.  
Push this button to set the trigger level to the midpoint of the waveform.

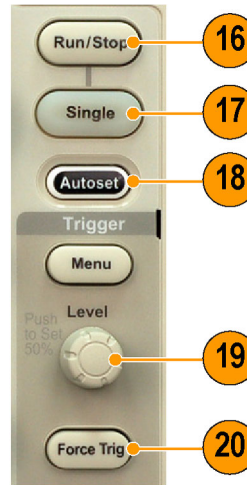

20. **Force Trig.** Push to force an immediate trigger event.

21. **Vertical Position.** Turn to adjust the vertical position of the corresponding waveform. Push **Fine** to make smaller adjustments.

22. 1, 2, 3, 4. Push to display or remove the corresponding waveform from the display and access the vertical menu.

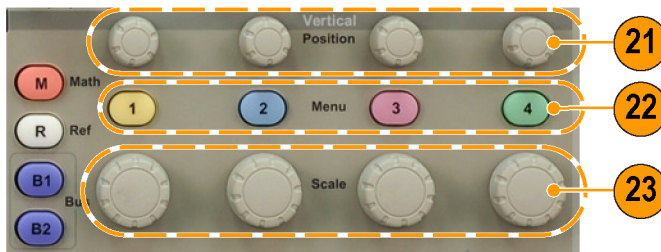

2410-020

23. **Vertical Scale.** Turn to adjust the vertical scale factor of the corresponding waveform (volts/division).

24. **Print.** Push to print a screen image using the printer selected in the Utility menu.

25. **Power switch.** Push to power on or off the instrument.

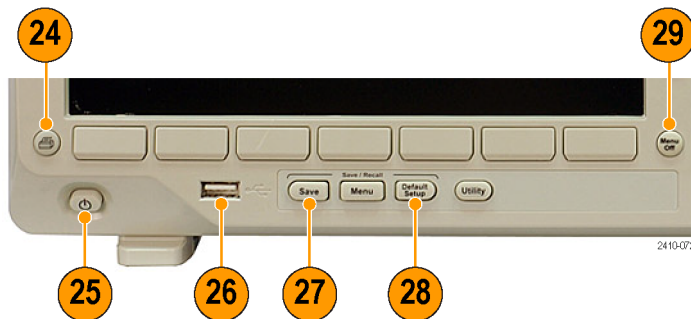

2410-072

- 26. USB 2.0 host port.** Insert a USB cable here to connect peripherals to the oscilloscope, such as a keyboard, a printer, or a flash drive. There is one more USB 2.0 host port on the rear panel.
  
- 27. Save.** Push to perform an immediate save operation. The save operation uses the current save parameters, as defined in the Save / Recall menu.
  
- 28. Default Setup.** Push to perform an immediate restore of the oscilloscope to the default settings.
  
- 29. Menu Off.** Push to clear a displayed menu from the screen.

## Identifying Items in the Display

The items shown to the right may appear in the display. Not all of these items are visible at any given time. Some readouts move outside the graticule area when menus are turned off.

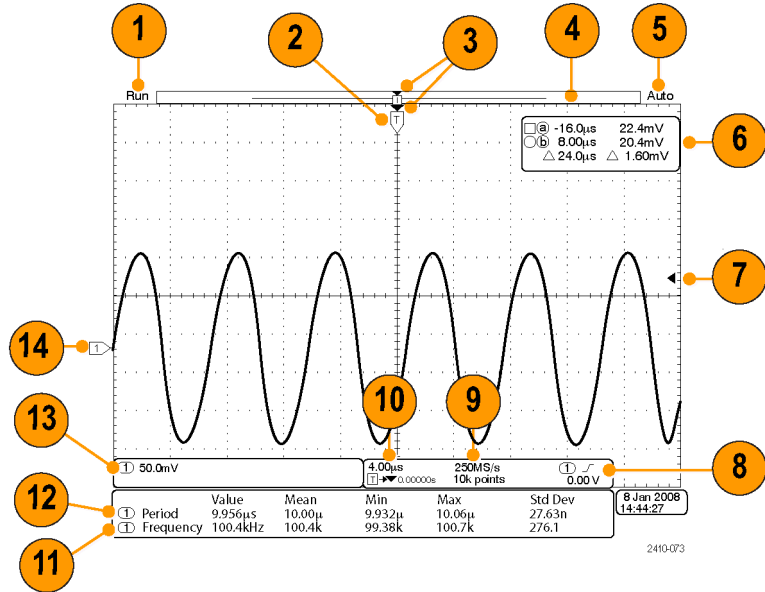



1. The acquisition readout shows when an acquisition is running, stopped, or when acquisition preview is in effect. Icons are:
  - Run: Acquisitions enabled
  - Stop: Acquisitions not enabled
  - Roll: In roll mode (40 ms/div or slower)
  - PreVu: In this state, the oscilloscope is stopped or between triggers. You can change the horizontal or vertical position or scale to see approximately what the next acquisition will look like.

2. The trigger position icon shows the trigger position in the acquisition.

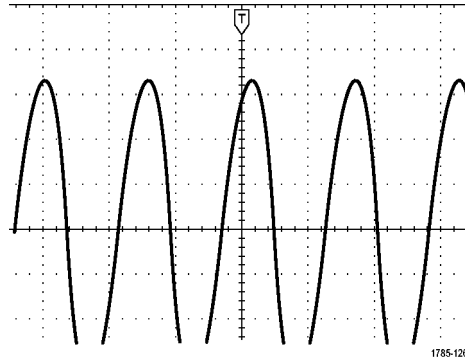

3. The expansion point icon (an orange triangle) shows the point that the horizontal scale expands and compresses around.

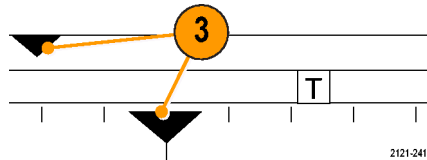

4. The waveform record view shows the trigger location relative to the waveform record. The line color corresponds to the selected waveform color.



5. The trigger status readout shows trigger status. Status conditions are:
- Trig'd: Triggered
  - Auto: Acquiring untriggered data
  - PrTrig: Acquiring pretrigger data
  - Trig?: Waiting for trigger
6. The cursor readout shows time, amplitude, and delta ( $\Delta$ ) values for each cursor.
- For FFT measurements, it shows frequency and magnitude.
- For serial buses, the readout shows the decoded values.

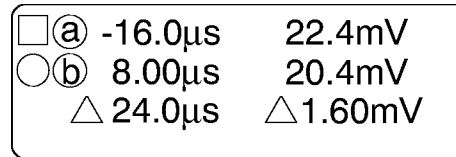

1785-134

7. The trigger level icon shows the trigger level on the waveform. The icon color corresponds to the trigger source color.

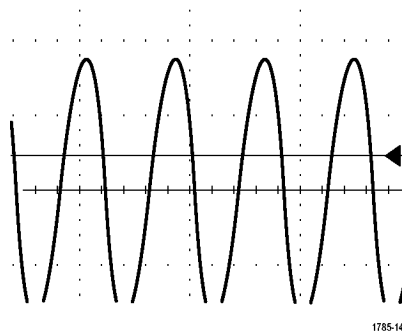

8. The trigger readout shows the trigger source, slope, and level. The trigger readouts for other trigger types show other parameters.

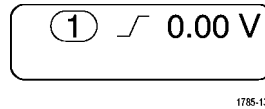

9. The top line of the record length/sampling rate readout shows the sampling rate (adjust with the **Horizontal Scale** knob). The bottom line shows the record length (adjust with the **Acquire** menu).

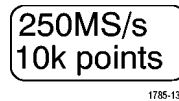

10. The horizontal position/scale readout shows on the top line the horizontal scale (adjust with the **Horizontal Scale** knob).

With **Delay Mode** on, the bottom line shows the time from the T symbol to the expansion point icon (adjust with the **Horizontal Position** knob).

Use horizontal position to insert added delay between when the trigger occurs and when you actually capture the data. Insert a negative time to capture more pretrigger information.

With **Delay Mode** off, the bottom line shows the time location of the trigger within the acquisition, as a percentage.

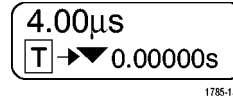

11. Measurement readouts show the selected measurements. You can select up to four measurements to display at one time.

①	Period	995 $\mu$ s
①	Freq	1.004 kHz

1785-144

A  symbol appears instead of the expected numerical measurement if a vertical clipping condition exists. Part of the waveform is above or below the display. To obtain a proper numerical measurement, turn the vertical scale and position knobs to make all of the waveform appear in the display.

12. The auxiliary waveform readouts show the vertical and horizontal scale factors of the math and reference waveforms.

(M)
-----

1785-138

13. The channel readout shows the channel scale factor (per division), coupling, invert, and bandwidth status. Adjust with the **Vertical Scale** knob and the channel **1, 2, 3, or 4** menus.

①	↓	20.0mV $\Omega$ $\mathbb{B}_w$
---	---	--------------------------------

2121-243

14. For analog channels, the waveform baseline indicator shows the zero-volt level of a waveform (ignoring the effect of offset). The icon colors correspond to the waveform colors.

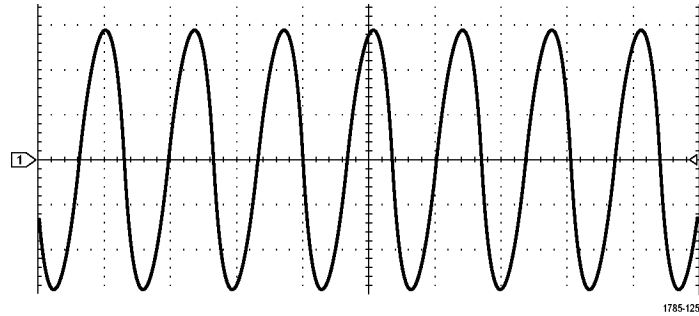

15. The bus display shows decoded packet level information for serial buses or for parallel buses.

## Front-Panel Connectors

1. Channel 1, 2, (3, 4). Channel inputs with the TekVPI Versatile Probe Interface.
2. **Aux In.** Trigger level range is adjustable from +8 V to -8 V. The maximum input voltage is 450V peak, 300V RMS. Input resistance is  $1\text{ M}\Omega \pm 1\%$  in parallel with  $11.5\text{ pF} \pm 2\text{ pF}$ .
3. **PROBE COMP.** Square wave signal source to compensate probes. Output voltage: 0 – 2.5V, amplitude  $\pm 1\%$  behind  $1\text{ k}\Omega \pm 2\%$ . Frequency: 1 kHz.
4. Ground.
5. Application Module Slots.

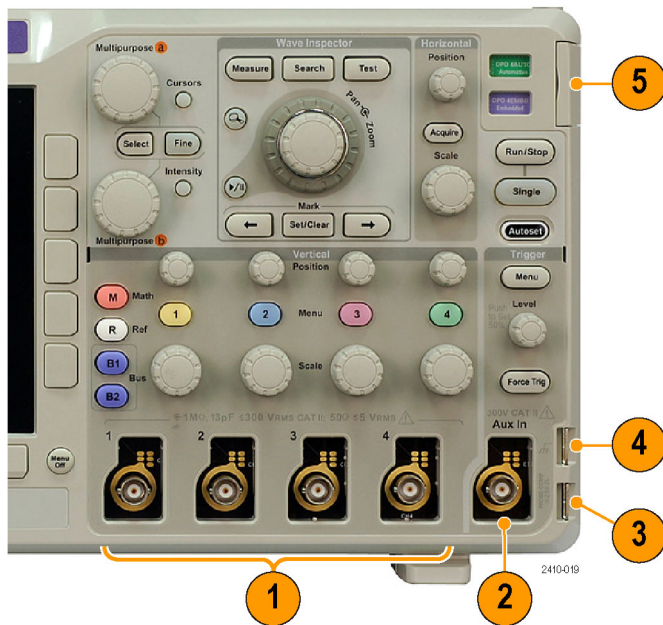



## Side-Panel Connector

1. Ground strap connector. This is a receptacle for a grounding strap.



## Rear-Panel Connectors

1. **Cal.** This is for use by authorized service personnel only.
2. **Aux Out.** Use this output to synchronize other test equipment with your oscilloscope. A LOW to HIGH transition indicates that the trigger occurred. The logic level for Vout (HI) is  $\geq 3.25\text{V}$  open circuit;  $\geq 2.2\text{ V}$  into a  $50\Omega$  load to ground. The logic level for Vout (LO) is  $\leq 0.4\text{ V}$  into a load of  $\leq 4\text{ mA}$ ;  $\leq 0.2\text{ V}$  into a  $50\Omega$  load to ground.
3. **Probe Power.** Use this port to provide auxiliary power for TekVPI probes, when needed.
4. **Video Out.** Use the Video Out port (DB-15 female connector) to show the oscilloscope display on an external monitor or projector.
5. **LAN.** Use the LAN (Ethernet) port (RJ-45 connector) to connect the oscilloscope to a 10/100 Base-T local area network.

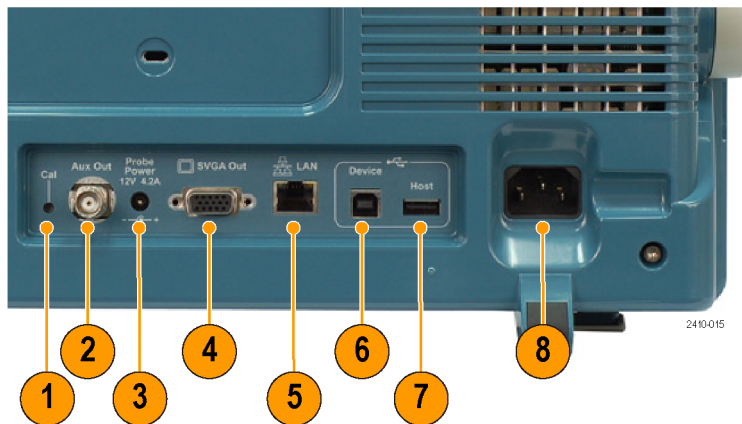

6. **Device.** Use the USB 2.0 High speed device port to control the oscilloscope through USBTMC or GPIB with a TEK-USB-488 Adapter. The USBTMC protocol allows USB devices to communicate using IEEE488 style messages. This lets you run your GPIB software applications on USB hardware.
  
7. **Host.** Use the USB 2.0 Full speed host ports (one on the rear-panel and one on the front) to take advantage of USB flash drives, keyboards, and printers.
  
8. **Power** input. Attach to an AC power line with integral safety ground. (See page 8, *Operating Considerations*.)

## Acquire the Signal

This section describes concepts of and procedures for setting up the oscilloscope to acquire the signal as you want it to.

### Setting Up Analog Channels

Use front-panel buttons and knobs to set up your instrument to acquire signals using the analog channels.

1. Connect the P6139A or TekVPI probe to the input signal source.

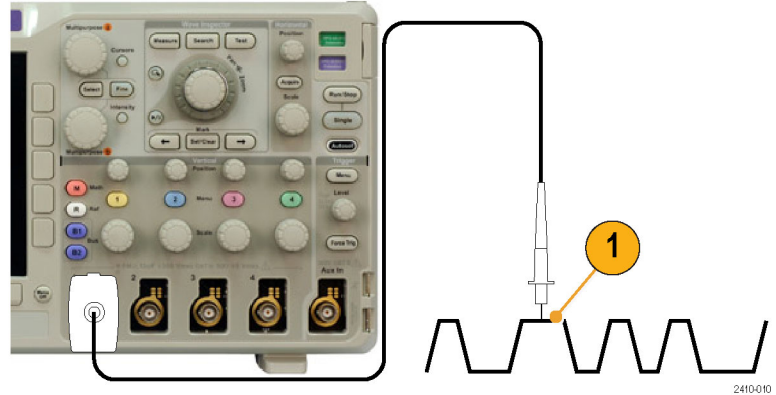

2. Push **Default Setup**.



3. Select the input channel by pushing the front-panel buttons.

**NOTE.** If you are using a probe that does not supply probe encoding, set the attenuation (probe factor) on the oscilloscope vertical menu for the channel to match the probe.

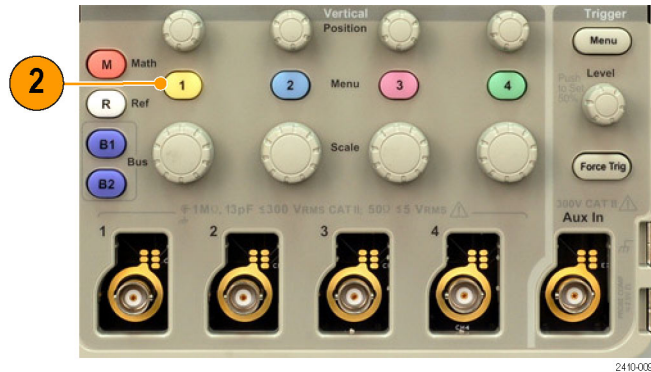

4. Push **Autoset**.



5. Push the desired channel button. Then adjust the vertical position and scale.

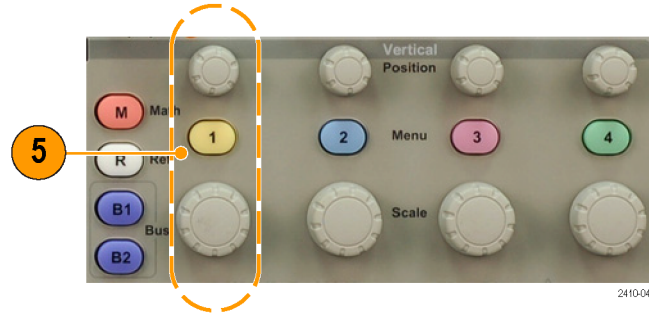

6. Adjust the horizontal position and scale.  
The horizontal position determines the number of pretrigger and posttrigger samples.  
The horizontal scale determines the size of the acquisition window relative to the waveform. You can scale the window to contain a waveform edge, a cycle, several cycles, or thousands of cycles.

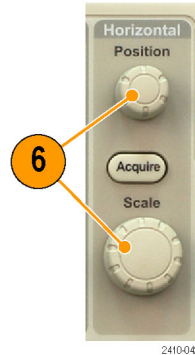

## Quick Tip

- Use the zoom feature to see multiple cycles of your signal in the upper part, and a single cycle in the lower part of the display. (See page 189, *Using Wave Inspector to Manage Long Record Length Waveforms.*)

## Labeling Channels and Buses

You can add a label to the channels and buses shown on the display for easy identification. The label is placed on the waveform baseline indicator in the left side of the screen. The label can have up to 32 characters.

To label a channel or bus, follow these steps:

1. Push a front panel button for an input channel or a bus.

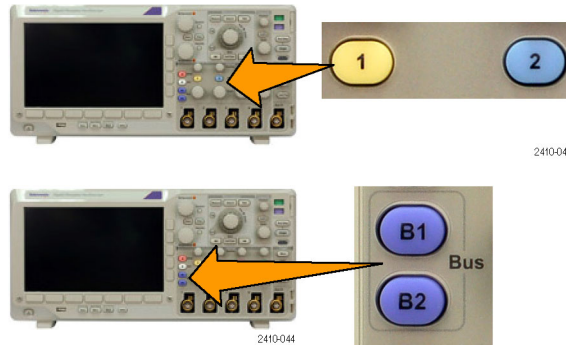

2. Push a lower-bezel **Label** button to create a label, such as for channel 1 or B1.



3. Push **Select Preset Label** to view a list of labels.



4. Turn multipurpose knob **b** to scroll through the list to find a suitable label. You can edit the label after you insert it if necessary.

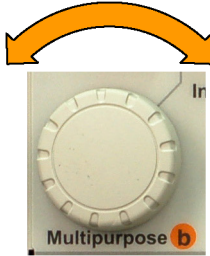

2410-046



5. Push **Insert Preset Label** to add the label.



If you are using a USB keyboard, use the arrow keys to position the insertion point and edit the inserted label, or type in a new label. (See page 48, *Connecting a USB Keyboard to Your Oscilloscope.*)

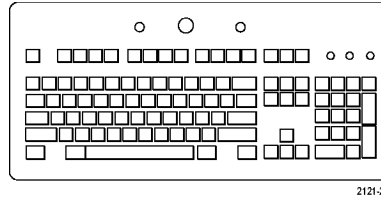

2121-230

6. If you do not have a USB keyboard connected, push the side- and lower-bezel arrow keys to position the insertion point.

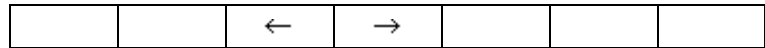
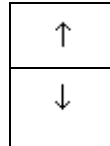

- Turn multipurpose knob **a** to scroll through the list of letters, numbers, and other characters to find the character in the name that you want to enter.



ABCDEFGHIJKLMNOPQRSTUVWXYZ  
 abcdefghijklmnopqrstuvwxyz  
 0123456789\_+!@#\$%^&\*()[]{}<>/~"|\:;.,?

- Push **Select** or **Enter Character** to let the oscilloscope know that you have picked the proper character to use.



You can use the lower-bezel buttons to edit the label as needed.

Enter Character		←	→	Back Space	Delete	Clear
-----------------	--	---	---	------------	--------	-------

- Continue scrolling and pushing **Select** until you have entered all the desired characters.  
For another label, push the side- and lower-bezel arrow keys to reposition the insertion point.
- Push **Display Labels** and select **On** to see the label.

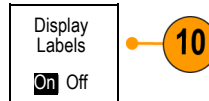

## Using the Default Setup

To return the oscilloscope to its default settings:

- Push **Default Setup**.



2. If you change your mind, push **Undo Default Setup** to undo the last default setup.



## Using Autoset

Autoset adjusts the instrument (acquisition, horizontal, trigger, and vertical controls) such that it displays four or five waveform cycles for analog channels with the trigger near the midlevel, and ten cycles for digital channels.

Autoset works with both the analog and digital channels.

1. Connect the analog probe, and then select the input channel. (See page 76, *Setting Up Analog Channels*.)

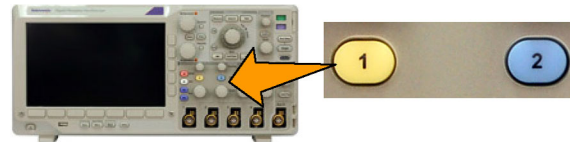

2410-043

2. Push **Autoset** to execute an Autoset.



2410-008

3. If desired, push **Undo Autoset** to undo the last Autoset.



## Quick Tips

- To position the waveform appropriately, Autoset may change the vertical position. Autoset always sets vertical offset to 0 V.
- If you use Autoset when no channels are displayed, the instrument turns on channel one (1) and scales it.
- If you use Autoset and the oscilloscope detects a video signal, the oscilloscope automatically sets the trigger type to video and makes other adjustments to display a stable video signal.

## Acquisition Concepts

Before a signal can be displayed, it must pass through the input channel where it is scaled and digitized. Each channel has a dedicated input amplifier and digitizer. Each channel produces a stream of digital data from which the instrument extracts waveform records.

## Sampling Process

Acquisition is the process of sampling an analog signal, converting it into digital data, and assembling it into a waveform record, which is then stored in acquisition memory.

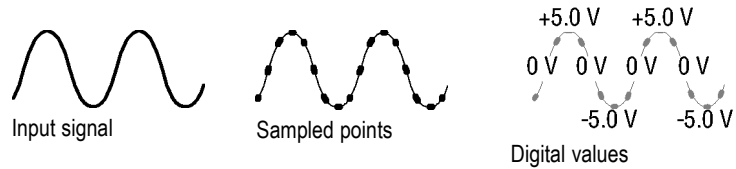

## Real-Time Sampling

DPO3000 series oscilloscopes use real-time sampling. In real-time sampling, the instrument digitizes all of the points it acquires using a single trigger event.

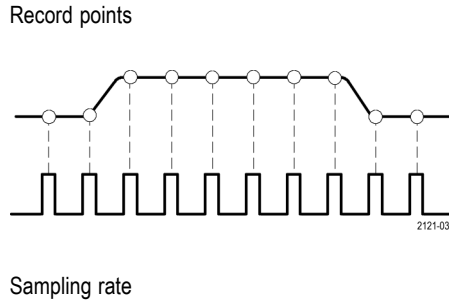

## Waveform Record

The instrument builds the waveform record through use of the following parameters:

- **Sample interval:** The time between recorded sample points. Adjust this by turning the **Horizontal Scale** knob or changing the record length with the bezel buttons.
- **Record length:** The number of samples required to fill a waveform record. Set this by pushing the **Acquire** button and using the resulting lower- and side-bezel menus.
- **Trigger point:** The zero time reference in a waveform record. It is shown on the screen by an orange T.

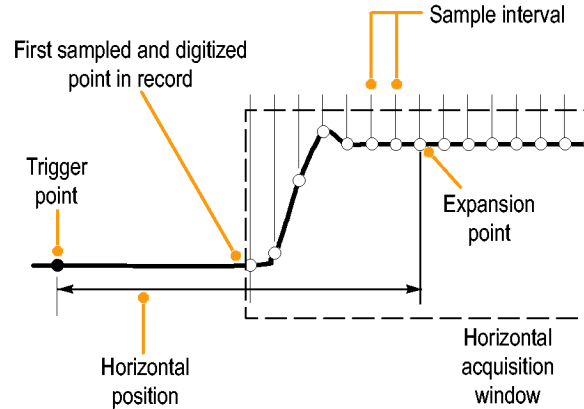

1785-109

- Horizontal position: When **Delay Mode** is on, this is the time from the trigger point to the expansion point. Adjust this by turning the **Horizontal Position** knob.  
Use a positive time to acquire the record after the trigger point. Use a negative time to acquire it before the trigger point.
- Expansion point: The point that the horizontal scale expands and contracts around. It is shown by an orange triangle.

## How the Analog Acquisition Modes Work

---

**Sample** mode retains the first sampled point from each acquisition interval. Sample is the default mode.

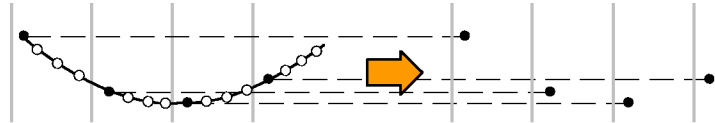



**Peak Detect** mode uses the highest and lowest of all the samples contained in two consecutive acquisition intervals. This mode only works with real-time, noninterpolated sampling and is useful for catching high frequency glitches.

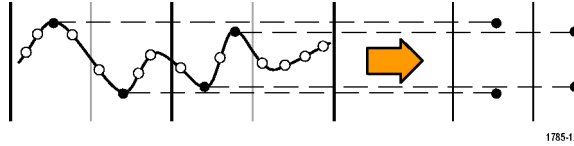

**Hi Res** mode calculates the average of all the samples for each acquisition interval. This mode only works with real-time, noninterpolated sampling. Hi-Res provides a higher-resolution, lower-bandwidth waveform.

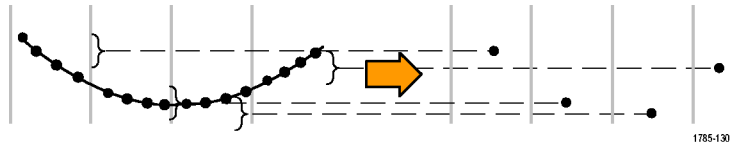

**Envelope** mode finds the highest and lowest record points over all acquisitions. Envelope uses Peak Detect for each individual acquisition.



**Average** mode calculates the average value for each record point over a user-specified number of acquisitions. Average uses Sample mode for each individual acquisition. Use average mode to reduce random noise.



## Changing the Acquisition Mode, Record Length, and Delay Time

Use this procedure to change the acquisition mode.

1. Push **Acquire**.



2. Push **Mode**.

Mode <b>Sample</b>	Record Length <b>10k</b>	Delay On <b>Off</b>	Set Horiz. Position to 10%	Waveform Display	XY Display <b>Off</b>	
<b>2</b>	<b>5</b>	<b>7</b>				

3. Then choose the acquisition mode from the side-bezel menu. You can choose from: Sample, Peak Detect, Hi Res, Envelope, or Average.

**NOTE.** Peak Detect and Hi Res modes take advantage of sample points that the oscilloscope would have discarded at lower sweep speeds. Therefore, these modes only work when the current sample rate is less than the maximum possible sample rate. As soon as the oscilloscope starts to acquire at the maximum sample rate, then the Peak Detect, Hi Res and Sample modes all look the same. You can control the sample rate by setting the Horizontal scale and the Record Length.

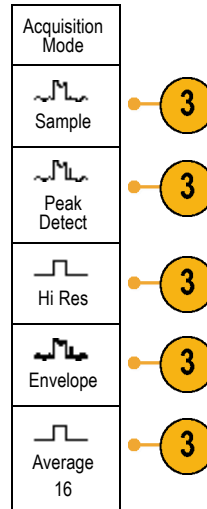

4. If you chose **Average**, turn multipurpose knob **a** to set the number of waveforms to average over.



5. Push **Record Length**.

6. Push the side-bezel menu, record length button.

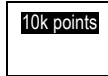

Choose among: 1000, 10 k, 100 k, 1 M, and 5 M points.

7. Push the lower-bezel **Delay** button to select **On** when you want to delay the acquisition relative to the trigger event.

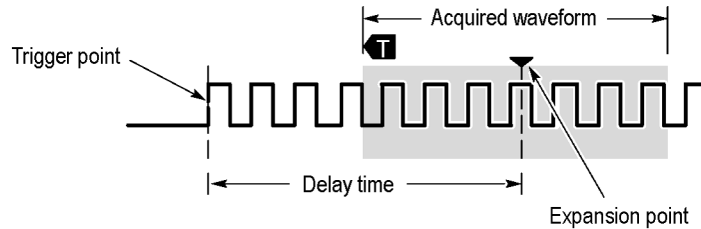

With **Delay** set to **On**, turn the **Horizontal Position** knob counterclockwise to increase the delay. The trigger point will move to the left and ultimately outside of the acquired waveform. Then you can adjust the **Horizontal Scale** knob to acquire more detail around the area of interest at the center of the screen.

When this delay is on, the trigger point separates from the horizontal expansion point. The horizontal expansion point stays at the center of the screen. The trigger point can move off the screen. When this happens, the trigger marker turns to point in the direction of the trigger point.

Use the delay feature when you want to acquire waveform detail that is separated from the trigger event by a significant interval of time. For example, you can trigger on a sync pulse that occurs once every 10 ms and then look at high-speed signal characteristics that occur 6 ms after the sync pulse.

When the delay feature is set to **Off**, the expansion point is tied to the trigger point so that scale changes are centered around the trigger point.

## Using Roll Mode

Roll mode gives a display similar to a strip chart recorder for low-frequency signals. Roll mode lets you see acquired data points without waiting for the acquisition of a complete waveform record.

Roll mode is enabled when the trigger mode is auto and the horizontal scale is set to 40 ms/div or slower.

## Quick Tips

- Switching to Envelope or Average acquisition mode, using math waveforms, turning on a bus, or switching to Normal trigger will disable Roll mode.
- Roll mode is disabled when you set the horizontal scale to 20 ms per division or faster.
- Push **Run/Stop** to halt Roll mode.



## Setting Up a Serial Bus

Your oscilloscope can decode and trigger on:

- I<sup>2</sup>C and SPI serial buses if the DPO3EMBD application module is installed
- CAN and LIN serial buses if the DPO3AUTO application module is installed
- RS-232, RS-422, RS-485, and UART serial buses if the DPO3COMP application module is installed

(See page 24, *Application Module Free Trial*.)

### Using Buses in Two Steps

To quickly use serial bus triggering:

1. Push **B1** or **B2** and enter parameters of the bus to trigger on.  
You can separately use **B1** and **B2** to view two different buses.

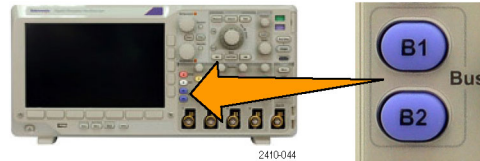

2. Push **Trigger Menu** and enter trigger parameters. (See page 114, *Choosing a Trigger Type*.)  
You can display bus information without triggering on the bus signal.



## Setting Up Bus Parameters

---

**NOTE.** For all serial bus sources, use channels 1 through 4.

---

To set up bus parameters:

1. Push **B1** or **B2** to bring up the lower-bezel bus menu.





2. Push **Bus**. Turn multipurpose knob **a** to scroll through the bus type side menu until you select the desired bus: I<sup>2</sup>C, SPI, CAN, RS-232, or LIN. The actual menu items shown will depend on your model oscilloscope and the application modules installed.

I <sup>2</sup> C
SPI
RS-232
CAN
LIN

3. Push **Define Inputs**.

B1 CAN	Define Inputs	Thresholds		B1 Label CAN	Bus Display	Event Table
-----------	---------------	------------	--	-----------------	-------------	-------------



4. If you selected **I<sup>2</sup>C** above, push **Define Inputs** and the desired side-bezel menu choices. You can assign the predefined **SCLK Input** or **SDA Input** to any channel.

B1 I <sup>2</sup> C	Define Inputs	Thresholds	Include R/W in Address No	B1 Label I <sup>2</sup> C	Bus Display	Event Table
------------------------	---------------	------------	------------------------------	------------------------------	-------------	-------------



5. For **I<sup>2</sup>C**, push **Include R/W in Address** and then push the desired side-bezel button for Yes or No.

This control determines how the oscilloscope shows the I<sup>2</sup>C addresses in bus decode traces, cursor readouts, Event Table listings, and trigger settings.

If you select Yes, then 7-bit addresses are displayed as eight bits, where the eighth bit (LSB) is the R/~W bit.

10-bit addresses are displayed as 11 bits. The first two bits are the two MSBs of the address. The next bit is the R/~W bit. The last eight bits are the eight LSBs of the address. (In the physical layer of the I<sup>2</sup>C protocol, 10 bit I<sup>2</sup>C addresses are preceded by the five bit code, 11110. The oscilloscope never includes these five bits in address readouts.)

If you select No, then 7-bit addresses are displayed as seven bits and 10-bit addresses are displayed as ten bits.

6. If you selected **SPI** above, push **Configure** and the desired side-bezel menu choice.

You can set the polarity for the SCLK, SS, MOSI, or MISO signals.

Active High means when a signal is greater than the threshold value, it is considered active. Active Low means when the signal is lower than the threshold value, it is considered active.

Bus <b>SPI</b>	Define Inputs	Thresholds	Configure	B1 Label SPI	Bus Display	Event Table
-------------------	------------------	------------	-----------	-----------------	-------------	-------------



7. If you selected **CAN** above, push **Bit Rate** and turn multipurpose knob **a** to select the desired bit rate.

Bus <b>CAN</b>	Define Inputs	Thresholds	Bit Rate <b>500 Kbps</b>	B1 Label CAN	Bus Display	Event Table
-------------------	------------------	------------	-----------------------------	-----------------	-------------	-------------



8. If you selected **RS-232** above, push **Configure**.

Use the side-bezel menu to configure the bus. Use Normal polarity to trigger on RS-232 signals and Inverted polarity to trigger on RS-422, 485, and UART signals.

Bus <b>RS-232</b>	Define Inputs	Thresholds	Configure <b>9600-8-N</b>	B1 Label RS-232	Bus Display	Event Table
----------------------	------------------	------------	------------------------------	--------------------	-------------	-------------



Push **Bit Rate**, and turn multipurpose knob **a** to select the appropriate bit rate.

Bit Rate 9600 bps
Data Bits 7 8
Parity None Odd Even
Packets On Off
End of Packet 0A (Linefeed)

RS-232 decoding displays a stream of bytes. You can organize the stream into packets with an end-of-packet character.

Turn multipurpose knob **a** to select an end-of-packet character.

- If you selected **LIN** above, push **Configure**.

Bus LIN	Define Inputs	Thresholds	Configure	B1 Label LIN	Bus Display	Event Table
------------	---------------	------------	-----------	-----------------	-------------	-------------

Use the side-bezel menu to configure the bus.



Push **Bit Rate**, and turn multipurpose knob **a** to select the appropriate bit rate.

Push **LIN Standard**, and turn multipurpose knob **a** to select the appropriate standard.

Push **Include Parity Bits with Id** to select whether or not to include parity bits.

Bit Rate <b>2400 bps</b>
LIN Standard <b>V1.x</b>
Include Parity Bits with Id Yes <b>No</b>

10. Push **Bus Display** and use the side-bezel menu to define how to display that bus.
- Push **Bus** to display packet level information decoded for easy visual inspection, much like what you would see on a logic analyzer.
  - Push **Bus and Waveforms** to display both views of the signal.

Push the desired side-bezel menu choice to display the bus data in hex, binary, decimal (for LIN), or ASCII (for RS-232) format.

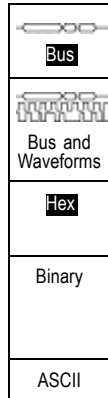

11. Push **Event Table** and select **On** to display a list of I<sup>2</sup>C, SPI, CAN, or LIN bus packets with timestamps.

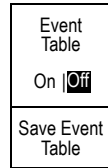

For an RS-232 bus, the table lists decoded bytes, or packets.

- Push **Save Event Table** to save the event table data in a .csv (spreadsheet) formatted file on the currently selected storage device.

Bus information example:

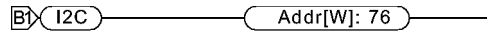

2121-235

Bus and waveforms example:

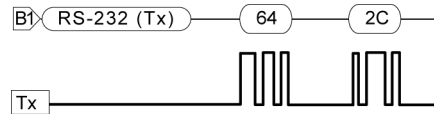

2121-231

Saved event table example:

I<sup>2</sup>C, SPI, CAN, and LIN event tables display one line for each packet.

RS-232 event tables display one line for each 7- or 8-bit byte when Packets are set to Off.

RS-232 event tables display one line for each packet when Packets are set to On.

Tektronix		version v1.2f	
Bus Definition: RS232			
Time	Tx	Rx	
-4.77E-02	E		
-4.44E-02	n		
-4.10E-02	g		
-3.75E-02	i		
-3.41E-02	n		
-3.08E-02	e		
-2.73E-02	e		
-2.39E-02	r		
-2.06E-02	i		
-1.71E-02	n		
-1.37E-02	g		
-1.03E-02	,		
-6.92E-03	SP		
-3.49E-03	P		
-5.38E-05	o		
3.28E-03	r		
6.71E-03	t		
1.69E-02	l		
2.02E-02	a		
2.43E-02	n		
2.82E-02	d		
3.16E-02			

2410-085

12. Push **B1** or **B2** and turn multipurpose knob **a** to move the bus display up or down on the screen.

To trigger on serial bus conditions, refer to Triggering on Buses. (See page 121, *Triggering on Buses.*)



## Physical Layer Bus Activity

Oscilloscope waveform traces from channels 1 to 4 and the traces you see when you choose to display a bus as Bus and Waveforms always show the physical layer bus activity. In the physical layer display, bits that were transmitted earlier are to the left, and bits that were transmitted later are to the right.

- I2C and CAN buses transmit the MSB (most significant bit) first
- SPI buses do not specify a bit order
- RS-232 and LIN buses transmit the LSB (least significant bit) first

---

**NOTE.** *The oscilloscope displays the decode traces and event tables for all buses with the MSB on the left and LSB on the right.*

---

For example, an RS-232 signal (after the start bit) might be high, high, high, low, high, low, low, and high. Since the RS-232 protocol uses high for zero and low for one, this value would be 0001 0110.

Since the decode displays the MSB first, the oscilloscope reverses the order of the bits and displays 0110 1000. If the bus display is set to hex, the value displays as 68. If the bus display is set to ASCII, the value displays as h.

## RS-232

If you defined an end-of-packet character to use for RS-232 decoding, the stream of bytes will be displayed as packets.

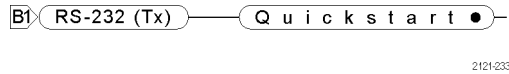

When decoding an RS-232 bus in ASCII mode, a large dot indicates that the value represents a character outside the printable ASCII range.

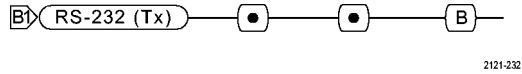

---

# Trigger Setup

This section contains concepts and procedures for setting up the oscilloscope to trigger on your signal.

## Triggering Concepts

### Trigger Event

The trigger event establishes the time-reference point in the waveform record. All waveform record data is located in time with respect to that point. The instrument continuously acquires and retains enough sample points to fill the pretrigger portion of the waveform record. That is the part of the waveform that is displayed before, or to the left of, the triggering event on screen. When a trigger event occurs, the instrument starts acquiring samples to build the posttrigger portion of the waveform record, that is, the part displayed after or to the right of the trigger event. After a trigger is recognized, the instrument will not accept another trigger until the acquisition is complete and the holdoff time has expired.

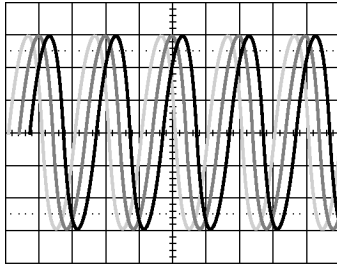

Untriggered display

1785-087a

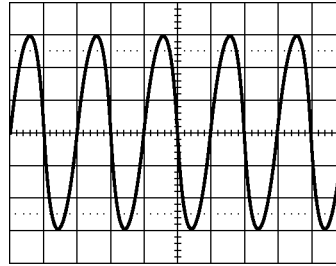

Triggered display

1785-087b

## Trigger Modes

The trigger mode determines how the instrument behaves in the absence of a trigger event:

- Normal trigger mode enables the instrument to acquire a waveform only when it is triggered. If no trigger occurs, the last waveform record acquired remains on the display. If no last waveform exists, no waveform is displayed.
- Auto trigger mode enables the instrument to acquire a waveform even if a trigger does not occur. Auto mode uses a timer that starts when the acquisition is started, and the pretrigger information is obtained. If a trigger event is not detected before the timer times out, the instrument forces a trigger. The length of time it waits for a trigger event depends on the time base setting.

Auto mode, when forcing triggers in the absence of valid triggering events, does not synchronize the waveform on the display. The waveform will appear to roll across the screen. If valid triggers occur, the display will become stable.

You can also force the instrument to trigger by pushing the front-panel **Force Trig** button.

## Trigger Holdoff

Adjust holdoff to obtain stable triggering when the instrument is triggering on undesired trigger events.

Trigger holdoff can help stabilize triggering, since the oscilloscope does not recognize new triggers during the holdoff time. When the instrument recognizes a trigger event, it disables the trigger system until acquisition is complete. In addition, the trigger system remains disabled during the holdoff period that follows each acquisition.

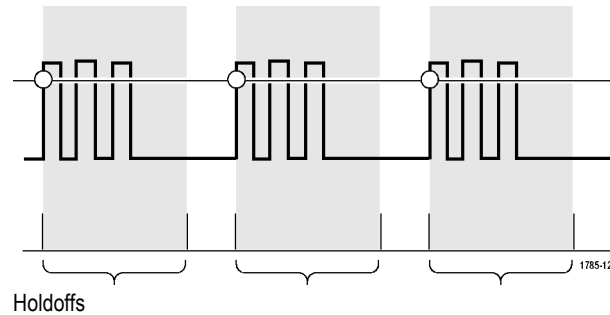

## Trigger Coupling

Trigger coupling determines what part of the signal is passed to the trigger circuit. Edge triggering can use all available coupling types: DC, AC, Low Frequency Rejection, High Frequency Rejection, and Noise Rejection. Sequence (B) triggering does not provide AC coupling. Other trigger types use DC coupling only.

## Horizontal Position

When **Delay Mode** is on, use horizontal position to acquire waveform detail in a region that is separated from the trigger location by a significant interval of time.

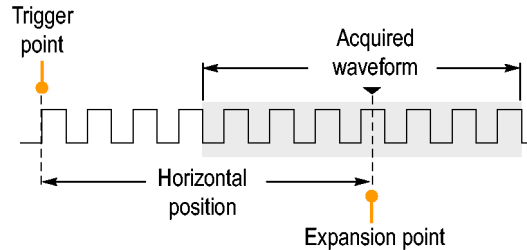

1. Adjust the position (delay) time by rotating the **Horizontal Position** knob.
2. Turn horizontal **SCALE** to acquire the detail that you need around the position (delay) expansion point.

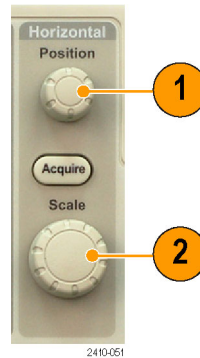

The part of the record that occurs before the trigger is the pretrigger portion. The part that occurs after the trigger is the posttrigger portion. Pretrigger data can help you troubleshoot. For example, to find the cause of an unwanted glitch in your test circuit, you can trigger on the glitch and make the pretrigger period large enough to capture data before the glitch. By analyzing what happens before the glitch, you may uncover information that helps you find the source of the glitch. Alternatively, to see what is happening in your system as a result of the trigger event, make the posttrigger period large enough to capture data after the trigger.

## Slope and Level

The slope control determines whether the instrument finds the trigger point on the rising or the falling edge of a signal.

The level control determines where on that edge the trigger point occurs.

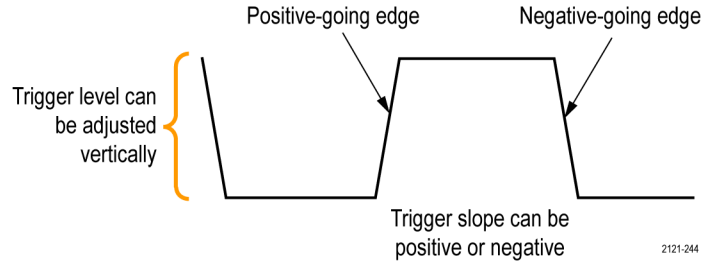

The oscilloscope provides a long horizontal bar or bars across the graticule to temporarily show the trigger level.

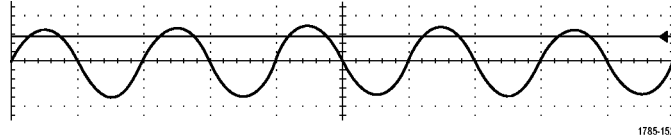



1. Turn the front-panel Trigger **Level** knob to adjust the trigger level without going to a menu.

Push the knob to quickly set the trigger level to the midpoint of the waveform.

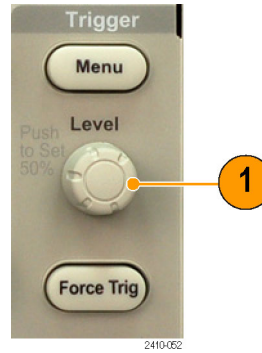

## Choosing a Trigger Type

To select a trigger:

1. Push Trigger **Menu**.



2. Push **Type** to bring up the **Trigger Type** side-bezel menu.

**NOTE.** The bus trigger requires use of the *DPO3EMBD*, *DPO3AUTO*, or *DPO3COMP* application module.

Trigger Type
Sequence (B Trigger)
Pulse Width
Runt
Logic
Setup & Hold
Rise/Fall Time
Video
Bus

3. Turn multipurpose knob **a** to select the desired trigger type.

- Complete the trigger setup using the lower-bezel menu controls displayed for the trigger type. The controls to set up the trigger vary depending on the trigger type.

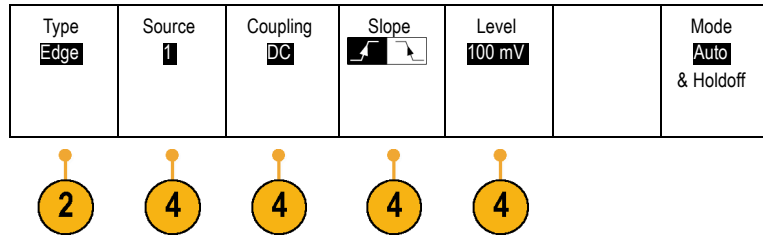

## Selecting Triggers

### Trigger Type

Edge

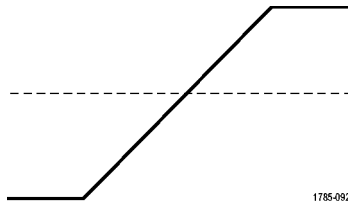

### Trigger Conditions

Trigger on a rising or falling edge, as defined by the slope control. Coupling choices are DC, AC, LF Reject, HF Reject, and Noise Reject.

Edge triggers are the simplest and most commonly used trigger type, with both analog and digital signals. An edge trigger event occurs when the trigger source passes through a specified voltage level in the specified direction.

### Trigger Type

Sequence  
(B Trigger)

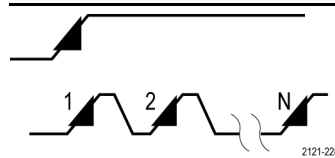
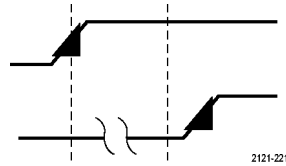

Pulse Width

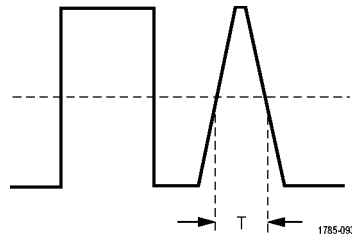

### Trigger Conditions

Combine an edge A Event (Main) trigger with the B Event (Delayed) trigger to capture more complex signals. (See page 131, *Using Sequence Trigger, A (Main) and B (Delayed).*)

**Time.** After the A Event occurs, the trigger system waits the specified amount of time, and then looks for the B Event before triggering and displaying the waveform.

**Events.** After the A Event occurs, the trigger system looks for a specified number of B Events before triggering and displaying the waveform.

Trigger on pulses that are less than, greater than, equal to, or not equal to a specified time. You can trigger on positive or negative pulses. Pulse width triggers are primarily used on digital signals.

### Trigger Type

Runt

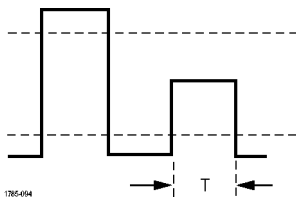

### Trigger Conditions

Trigger on a pulse amplitude that crosses one threshold but fails to cross a second threshold before recrossing the first. You can detect positive or negative (or either) runts, or only those wider than, less than, greater than, equal to, or not equal to a specified width. Runt triggers are primarily used on digital signals.

Logic

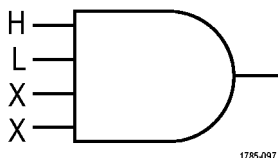

Trigger when all channels transition to the specified state. Use multipurpose knob **a** to select a channel. Push the appropriate side-bezel button to set that channel's state to **High (H)**, **Low (L)**, or **Don't Care (X)**.

Use the **Clock** side-bezel button to enable clocked (state) triggering. You can have at most a single clock channel. Push the **Clock Edge** bottom bezel button to change the polarity of the clock edge. Turn off clocked triggering and return to unclocked (pattern) triggering by selecting the clock channel and setting it to high, low, or don't care.

For unclocked triggering, by default, triggering occurs when the selected condition goes true. You can also select triggering when the condition goes false, or time-qualified triggering.

### Trigger Type

#### Setup and Hold

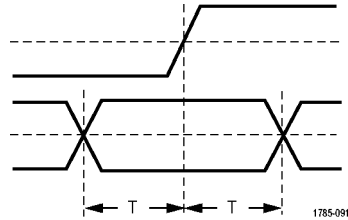

### Trigger Conditions

Trigger when a logic data input changes state inside of the setup or hold time relative to a clock edge.

Setup is the amount of time that data should be stable and not change before a clock edge occurs. Hold is the time that data should be stable and not change after a clock edge occurs.

Use the **Clock** side-bezel button to select the clock channel. Use the **Select** control, **Data**, and **Not used** buttons to select one or more channels you want to monitor for setup and hold violations.

**NOTE.** Optimum Setup and Hold trigger performance is achieved by using only analog channels or only digital channels.

#### Rise/Fall Time

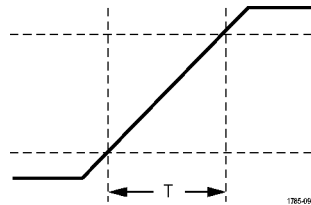

Trigger on rise and fall times. Trigger on pulse edges that traverse between two thresholds at faster or slower rates than the specified time. Specify pulse edges as positive, negative, or either.

### Trigger Type

Video



### Trigger Conditions

Trigger on specified fields or lines of a composite video signal. Only composite signal formats are supported.

Trigger on NTSC, PAL, or SECAM. Works with Macrovision signals.

With the DPO3VID module, trigger on a variety of HDTV video standard signals, as well as custom (non-standard) bilevel and trilevel video signals with 3 to 4,000 lines.

Bus

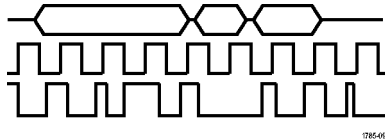

Trigger on various bus conditions.

I<sup>2</sup>C requires a DPO3EMBD module.

SPI requires a DPO3EMBD module.

CAN requires a DPO3AUTO module.

RS-232, RS-422, RS-485, and UART require a DPO3COMP module.

LIN requires either a DPO3AUTO module.

(See page 24, *Application Module Free Trial*.)



## Triggering on Buses

You can use your oscilloscope to trigger on CAN, LIN, I<sup>2</sup>C, SPI, RS-232, RS-422, RS-485, and UART buses, if you have the appropriate DPO3AUTO, DPO3EMBD, or DPO3COMP application module installed. The oscilloscope can display both physical layer (as analog waveforms) and protocol level information (as digital and symbolic waveforms).

To set up the bus trigger:

1. If you have not already defined your bus using the front-panel **B1** and **B2** buttons, do so now. (See page 95, *Setting Up a Serial Bus*.)

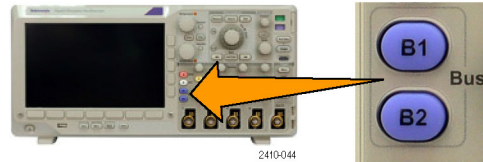

2. Push Trigger **Menu**.



3. Push **Type**.

Type <b>Bus</b>	Source Bus <b>B1 (I2C)</b>	Trigger On <b>Address</b>	Address <b>07F</b>		Direction <b>Write</b>	Mode <b>Auto</b> & Holdoff
--------------------	-------------------------------	------------------------------	-----------------------	--	---------------------------	----------------------------------

4. Turn multipurpose knob **a** to scroll through the trigger type side menu until you select **Bus**.



5. Push **Source Bus** and turn multipurpose knob **a** to scroll through the source bus side menu until you select the bus that you want to trigger on.

B1 (I2C)
B2 (CAN)

6. Push **Trigger On** and turn multipurpose knob **a** to scroll through the side-bezel menu until you select the desired trigger on feature.

If you are using the I2C bus trigger, you can trigger on **Start, Repeated Start, Stop, Missing Ack, Address, Data, or Address/Data**.

If you are using the SPI bus trigger, you can trigger on **SS Active, MOSI, MISO, or MOSI & MISO**.

If you are using the CAN bus trigger, you can trigger on **Start of Frame, Type of Frame, Identifier, Data, Id & Data, End of Frame, and Missing Ack**.

If you are using the RS-232 bus trigger, you can trigger on **Tx Start Bit, Rx Start Bit, Tx End of Packet, Rx End of Packet, Tx Data, or Rx Data**.

If you are using the LIN bus trigger, you can trigger on **Sync, Identifier, Data, Id & Data, Wakeup Frame, Sleep Frame, or Error**.

7. If you are setting up an I<sup>2</sup>C trigger and have made a **Trigger On** selection of **Address** or **Address/Data**, push the lower-bezel **Address** button to access the I<sup>2</sup>C Address side-bezel menu.

Push the side-bezel **Addressing Mode** button and select **7 bit** or **10 bit**. Push the side-bezel **Address** button. Enter the address parameters of interest with multipurpose knobs **a** and **b**.

Then push the lower-bezel menu **Direction** button and select the direction of interest: **Read**, **Write**, or **Read or Write**.

If you have made a **Trigger On** selection of **Data** or **Address/Data**, push the lower-bezel **Data** button to access the I<sup>2</sup>C Data side-bezel menu.

Push the **Number of Bytes** button and enter the number of bytes with multipurpose knob **a**.

Push the side-bezel **Addressing Mode** button and select **7 bit** or **10 bit**. Push the side-bezel **Data** button. Enter the data parameters of interest with multipurpose knobs **a** and **b**.

For more information on the I<sup>2</sup>C address formats, refer to item 5 under *Setting Up Bus Parameters*.

8. If you are setting up an SPI trigger and have made a **Trigger On** selection of **MOSI** or **MISO**, push the lower-bezel **Data** button, push the side-bezel **MOSI** (or **MISO**) button, and enter the data parameters of interest with multipurpose knobs **a** and **b**.

Then push the **Number of Bytes** button and enter the number of bytes with multipurpose knob **a**.

If you select **MOSI & MISO**, push the lower-bezel **Data** button and enter the parameters of interest in the side-bezel menus.

9. If you are setting up a CAN trigger and have made a **Trigger On** selection of **Type of Frame**, push the lower-bezel **Frame Type** button, and select Data Frame, Remote Frame, Error Frame, or Overload Frame.

If you have made a **Trigger On** selection of **Identifier**, push the lower-bezel **Identifier** button, and select a **Format**. Then push the **Identifier** side-bezel button, and enter a binary or hex value with multipurpose knobs **a** and **b**.

Push the lower-bezel menu **Direction** button and select the direction of interest: **Read**, **Write**, or **Read or Write**.

If you have made a **Trigger On** selection of **Data**. Push the lower-bezel **Data** button and enter the parameters of interest with multipurpose knobs **a** and **b**.

10. If you are setting up an RS-232 trigger and have made a **Trigger On** selection of **Tx Data** or **Rx Data**, push the lower-bezel **Data** button.  
Push the **Number of Bytes** button and enter the number of bytes with multipurpose knob **a**.  
Push the side-bezel **Data** button, and enter the parameters of interest with multipurpose knobs **a** and **b**.
11. If you are setting up an LIN trigger and have made a **Trigger On** selection of **Identifier**, **Data**, or **Identifier & Data**, push the lower-bezel **Identifier** or **Data** buttons and enter the parameters of interest on the resulting side-bezel menu.  
If you have made a **Trigger On** selection of **Error**, push the lower-bezel **Error Type** button and enter the parameters of interest on the resulting side-bezel menu.

## I<sup>2</sup>C, SPI, CAN, and LIN Bus Trigger Data Matching

**Rolling window byte matching for I<sup>2</sup>C and SPI.** To use a rolling window to trigger on data, you define the number of bytes to match. Then the oscilloscope uses a rolling window to find any match within a packet, with the window rolling one byte at a time.



For example, if the number of bytes is one, the oscilloscope will attempt to match the first byte, second byte, third, and so on within the packet.

If the number of bytes is two, the oscilloscope will try to match any two consecutive bytes, such as one and two, two and three, three and four, and so on. If the oscilloscope finds a match, it will trigger.

**Specific byte matching (non-rolling window matching for a specific position in the packet) for I<sup>2</sup>C, SPI, and CAN.** You can trigger on a specific byte for I<sup>2</sup>C, SPI and CAN in several ways:

- For I<sup>2</sup>C and SPI, enter the number of bytes to match the number of bytes in the signal. Then use don't cares (X) to mask the bytes that you are not interested in.
- For I<sup>2</sup>C, push the lower-bezel **Trigger On** to trigger on **Address/Data**. Push **Address**. On the side-bezel menu, push **Address**, and rotate multipurpose knobs **a** and **b** as needed. Set the address to don't cares (X) if you want to mask the address. The data will be matched starting at the first byte without using a rolling window.
- For CAN, triggering occurs when the user-selected data input matches the data and qualifier in the signal starting at the first byte. Set the number of bytes to match the number of bytes of interest. Use the data qualifier to perform: =, !=, <, >, >=, and <= operations. Triggering on identifier and data always matches the identifier and data selected by the user, with the data starting at the first byte. No rolling window is used.

## RS-232 Bus Trigger Data Matching

You can trigger on a specific data value for RS-232 bytes. If you defined an end-of-packet character to use for RS-232 bus decoding, you can use the same end-of-packet character as a data value for trigger data matching. To do so, choose the Tx End of Packet or the Rx End of Packet character as the Trigger On selection.

## Checking Trigger Settings

To quickly determine the settings of some key trigger parameters, check the Trigger readout at the bottom of the display. The readouts differ for edge and the advanced triggers.

1. Trigger source = channel 1.
2. Trigger slope = rising.
3. Trigger level = 0.00 V.

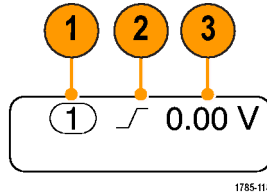

Edge trigger readout

## Using Sequence Trigger, A (Main) and B (Delayed)

Combine an edge A Event (Main) trigger with the B Event (Delayed) trigger to capture more complex signals. After the A Event occurs, the trigger system looks for the B Event before triggering and displaying the waveform.

A and B triggers can (and typically do) have separate sources.

Use the Edge trigger menu to set up the A trigger first. Then, to use the B trigger:

1. Push Trigger **Menu**.



2. Push **Type**.
3. Turn multipurpose knob **a** to select a trigger type of **Sequence (B Trigger)**.  
This brings up the Sequence (B Trigger) menu.

4. Push **B Trigger After A**.

Type Sequence (B Trigger)	Source 1	Coupling DC	Slope 	Level 0.00 V	B Trigger After A Time	Mode Auto & Holdoff
---------------------------------	-------------	----------------	-----------	-----------------	------------------------------	---------------------------



Push a side-bezel button to select sequencing the B trigger after the A as Time or as Events.

Time (a) 8 ns
B Events 1
Set to Minimum

5. Set the other Sequence Trigger parameters in the related side- and lower-bezel menus.

## B Trigger After Delay Time

The A trigger arms the instrument. Posttrigger acquisition starts on the first B edge after the trigger delay time.

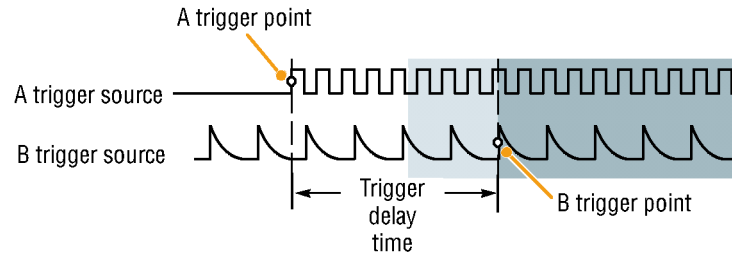

## Trigger on B Events

The A trigger arms the instrument. Posttrigger acquisition starts on the nth B event.

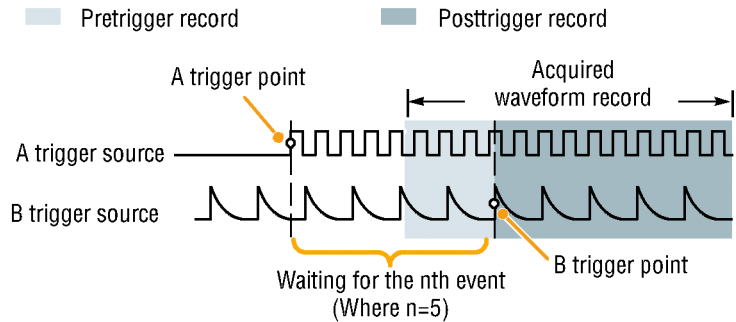

### Quick Tips

- B-trigger delay time and horizontal position are independent functions. When you establish a trigger condition using either the A trigger alone or the A and B triggers together, you can also use the horizontal position control to delay the acquisition by an additional amount.
- When using the B trigger, the A and B trigger types can only be Edge.

## Starting and Stopping an Acquisition

After you have defined the acquisition and trigger parameters, start the acquisition with **Run/Stop** or **Single**.

- Push **Run/Stop** to start acquisitions. The oscilloscope acquires repeatedly until you push the button again to stop the acquisition.
- Push **Single** to take a single acquisition. Single sets the trigger mode to **Normal** for the single acquisition.



2410-053

## Display Waveform Data

This section contains concepts and procedures for displaying the acquired waveform.

### Adding and Removing a Waveform

1. To add or remove a waveform from the display, push the corresponding front-panel channel button.

You can use the channel as a trigger source whether or not it is displayed.

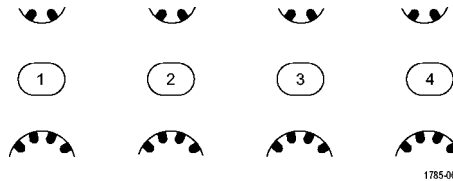

### Setting the Display Style and Persistence



1. To set the display style, push **Acquire**.





## 2. Push **Waveform Display**.

Mode <b>Sample</b>	Record Length <b>10k</b>	Delay On <b>Off</b>	Set Horiz. Position to 10%	Waveform Display	XY Display <b>On</b>	
-----------------------	-----------------------------	------------------------	-------------------------------	------------------	-------------------------	--

3. Push **Dots Only** from the side-bezel menu. Dots on will display the waveform record points as dots on the screen. Dots off connects the dots with vectors.

4. Push **Persist Time**, and turn multipurpose knob **a** to have waveform data remain on screen for a user-specified amount of time.

5. Push **Set to Auto** to have the oscilloscope automatically determine a persistence time for you.

6. Push **Clear Persistence** to reset the persistence information.

7. To display the amplitude from one waveform against the amplitude from another, push **XY Display**. Then push **Triggered XY** from the side menu.

A data point from the first waveform specifies the horizontal location while the corresponding data point from the second waveform specifies the vertical location for each displayed point.

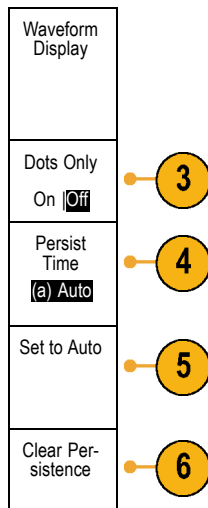

## Quick Tips

- Variable persistence accumulates record points for a specified time interval. Each record point decays independently according to the time interval. Use variable persistence for displaying infrequently appearing signal anomalies, such as glitches.
- Infinite persistence continuously accumulates record points until you change one of the acquisition display settings. Use infinite persistence for displaying unique signal anomalies, such as glitches.
- The XY Display mode graphs the data in fixed pairs of waveforms against one another. You can use CH1 versus CH2, and REF1 versus REF2. On four-channel models, you can also use CH3 versus CH4, and REF3 versus REF4.
- When the XY Display is on, an upper window appears that displays data versus time.

## Setting the Graticule Style

1. To set the graticule style, push **Utility**.



2. Push **Utility Page**.

Utility Page



3. Turn multipurpose knob **a** and select **Display**.

Display

4. Push **Graticule** from the lower-bezel menu.

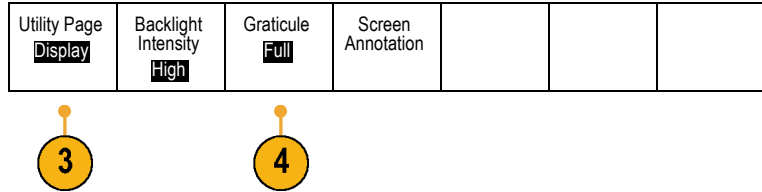

5. Select the desired style from the resulting side-bezel menu.

Use the **Full** graticule for quick estimates of waveform parameters.

Use the **Grid** graticule for full-screen measurements with cursors and automatic readouts when cross hairs are not needed.

Use the **Cross Hair** graticule for making quick estimates of waveforms while leaving more room for automatic readouts and other data.

Use the **Frame** graticule with automatic readouts and other screen text when display features are not needed.

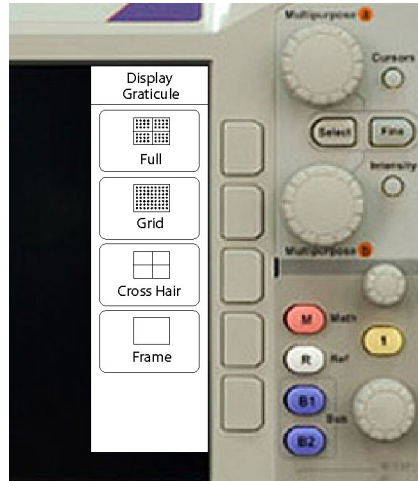

2410-074

## Quick Tips

- You can display IRE and mV graticules. To do this, set the trigger type to video and set the vertical scale to 143 mV/division. (The 143 mV/division selection is available in the coarse vertical scale settings for the channel when you set the trigger type to video.) The oscilloscope will automatically display the IRE graticule for NTSC signals, and the mV graticule for other video signals (PAL, SECAM, HDTV, and custom).

## Setting the LCD Backlight

1. Push **Utility**.



2. Push **Utility Page**.

Utility Page



3. Turn multipurpose knob **a** and select **Display**.

Display

4. Push **Backlight Intensity**.

Utility Page <b>Display</b>	Backlight Intensity <b>High</b>	Graticule <b>Full</b>	Screen Annotation			
--------------------------------	------------------------------------	--------------------------	-------------------	--	--	--



5. Select the intensity level from the resulting side-bezel menu. Choices are: **High**, **Medium**, and **Low**.

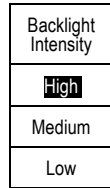

## Setting Waveform Intensity

1. Push the front-panel **Intensity** button.



This will bring up the intensity readout on the display.

- a) Waveform Intensity: 35%
- b) Graticule Intensity: 75%

2121-245

2. Rotate multipurpose knob **a** to select the desired waveform intensity.



2410-045

3. Rotate multipurpose knob **b** to select the desired intensity for the graticule.
4. Push **Intensity** again to clear the intensity readout from the display.



2410-054

## Scaling and Positioning a Waveform

Use the horizontal controls to adjust the time base, adjust the trigger point, and to examine waveform details more closely. You can also use the Wave Inspector Pan and Zoom controls to adjust the display of waveforms. (See page 189, *Using Wave Inspector to Manage Long Record Length Waveforms.*)



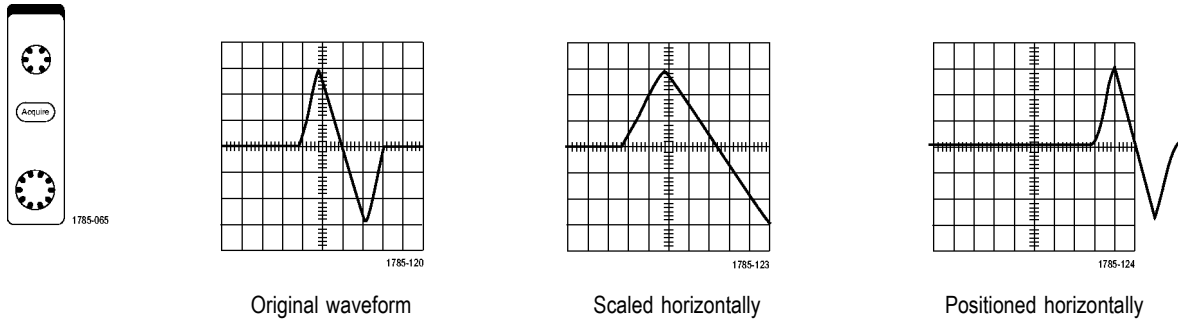

Use the vertical controls to select waveforms, adjust the waveform vertical position and scale, and set input parameters. Push a channel menu button (1, 2, 3, or 4) as many times as needed and the associated menu items to select, add, or remove a waveform.

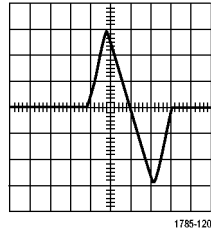
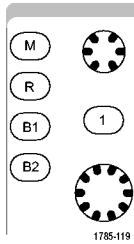

Original waveform

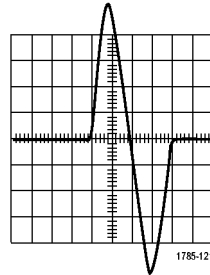

Scaled vertically

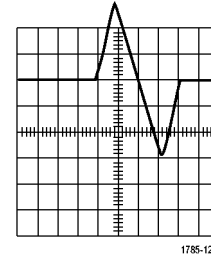

Positioned vertically

### Quick Tips

- **Preview.** If you change the Position or Scale controls when the acquisition is stopped or when it is waiting for the next trigger, the oscilloscope rescales and repositions the relevant waveforms in response to the new control settings. It simulates what you will see when you next push the **RUN** button. The oscilloscope uses the new settings for the next acquisition.

You may see a clipped waveform if the original acquisition went off the screen.

The math waveform, cursors, and automatic measurements remain active and valid when using preview.

## Setting Input Parameters

Use the vertical controls to select waveforms, adjust the waveform vertical position and scale, and set input parameters.

1. Push a channel menu button **1**, **2**, **3**, or **4** to bring up the vertical menu for the designated waveform. The vertical menu only affects the selected waveform.

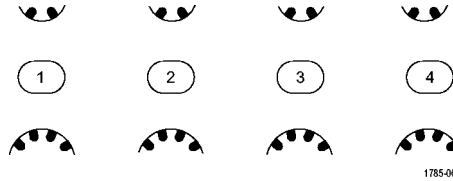

Pushing a channel button will also select or cancel that waveform selection.

2. Push **Coupling** repeatedly to select the coupling to use.  
Use DC coupling to pass both AC and DC components.

Use AC coupling to block the DC component and show only the AC signal.

Use Ground (GND) to display the reference potential.

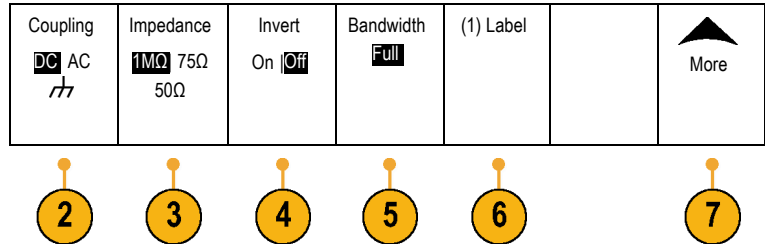

3. Push **Impedance** repeatedly to select the input impedance to use.  
Set the input impedance (termination) to 50  $\Omega$ , 75  $\Omega$ , or 1 M $\Omega$  if using DC or Gnd coupling. Input impedance is automatically set to 1 M $\Omega$  when using AC coupling.  
For more information on input impedance, see **Quick Tips**. (See page 150, *Quick Tips*.)
4. Push **Invert** to invert the signal.  
Select **Off** for normal operation and **On** to invert the polarity of the signal in the preamplifier.
5. Push **Bandwidth**, and select the desired bandwidth from the resulting side-bezel menu.  
The set choices are: Full and 20 MHz.  
Additional choices may appear, depending on the probe that you use.  
Select **Full** to set the bandwidth to the full oscilloscope bandwidth.  
Select **20 MHz** to set the bandwidth to 20 MHz.
6. Push **Label** to create a label for the channel.  
(See page 79, *Labeling Channels and Buses*.)

7. Push **More** to access additional side-bezel menus.

8. Select **Fine Scale** to enable multipurpose knob **a** to make fine vertical scale adjustments.

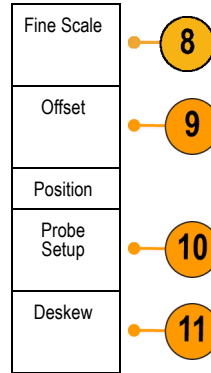

9. Select **Offset** to enable multipurpose knob **a** to make vertical offset adjustments.  
On the side-bezel menu, choose **Set to 0 V** to set the vertical offset to 0 V.  
For more information on offset, see **Quick Tips**. (See page 150, *Quick Tips*.)

10. Select **Probe Setup** to define probe parameters.  
On the resulting side-bezel menu:
  - Select **Voltage** or **Current** to set the probe type for probes that do not have the TekProbe II or TekVPI interface.
  - Use multipurpose knob **a** to set the attenuation to match the probe.
11. Select **Deskew** to set the time skew correction for the channel. Turn multipurpose knob **a** to adjust the time skew (deskew) correction for the probe attached to the selected channel. This shifts acquisition and display of the waveform left or right, relative to the trigger time. Use this to compensate for differences in cable lengths or probe types.

### Quick Tips

- **Using Probes with the TekProbe II and TekVPI Interfaces.** When you attach a probe with the TekProbe II or the TekVPI interface, the oscilloscope sets the channel sensitivity, coupling, and termination resistance automatically to match the probe requirements. Tek Probe II probes require use of the TPA-BNC Adapter.

- **The Difference Between Vertical Position and Offset.** Vertical position is a display function. Adjust the vertical position to place the waveforms where you want to see them. The waveform baseline locations track adjustments made to their positions.

When you adjust vertical offset, you see a similar effect, but it is actually quite different. Vertical offset is applied before the oscilloscope preamplifier and can be used to increase the effective dynamic range of the inputs. For example, you can use vertical offset to look at small variations in a large DC voltage. Set the vertical offset to match the nominal DC voltage and the signal appears in the center of the screen.

- **50 and 75  $\Omega$  Protection.** If you select 50  $\Omega$  or 75  $\Omega$  termination, the maximum vertical scale factor is limited to 1 V/div, except that with a 10X probe the scale factor is 10 V. If you apply excessive input voltage, the oscilloscope automatically switches to 1 M $\Omega$  termination to protect the internal 50  $\Omega$  or 75  $\Omega$  termination. For more details, refer to the specifications in the *DPO3000 Series Oscilloscopes Technical Reference*.

## Positioning and Labeling Bus Signals

**Positioning Bus Signals.** Push the appropriate front-panel bus button and turn multipurpose knob **a** to adjust the vertical position of the selected bus. (See page 95, *Setting Up a Serial Bus*.)

1. Push the appropriate front-panel bus button to select that bus.



- Turn multipurpose knob **a** to adjust the vertical position of the selected bus.



2410-045

**Labeling Bus Signals.** To label a bus, do the following steps:

- Push the appropriate front-panel bus button.



2410-044

- Push **Label**.  
(See page 79, *Labeling Channels and Buses.*)

Bus (B1) Parallel	Define Inputs	Thresholds		(B1) Label Parallel	Bus Display	Event Table
----------------------	------------------	------------	--	------------------------	-------------	-------------





## Annotating the Screen

You can add your own text to the screen by doing the following:

1. Push **Utility**.



2. Push **Utility Page**.



3. Turn multipurpose knob **a** and select **Display**.

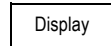

4. Push **Screen Annotation** from the resulting lower-bezel menu.

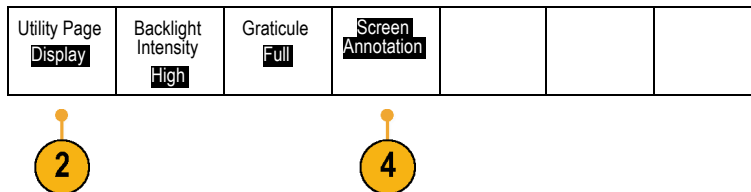

5. Push **Display Annotation** to select **On** from the side-bezel menu.  
The annotation window now appears. Position it by turning multipurpose knobs **a** and **b**.

6. Push **Edit Annotation** from the side-bezel menu

7. Turn multipurpose knob **a** to scroll through the list of letters, numbers, and other characters to select each desired character.

Alternatively, use a US-style USB keyboard to type in characters. (See page 48, *Connecting a USB Keyboard to Your Oscilloscope*.)

To reposition the annotated text, press the side-bezel **Position** button and turn multipurpose knobs **a** and **b**, as desired.

## Analyze Waveform Data

After having properly set up the acquisition, triggering, and display of your desired waveform, you can then analyze the results. Select from features such as cursors, automatic measurements, statistics, math, and FFT.

### Taking Automatic Measurements

To take an automatic measurement:

1. Push **Measure**.



2. Push **Add Measurement**.



3. Turn multipurpose knob **a** to select the specific measurement. If needed, then turn multipurpose knob **b** to select the channel to measure on.



4. To remove a measurement, push **Remove Measurement**, turn multipurpose knob **a** to select the specific measurement, and push **OK Remove Measurement** on the side-bezel menu.





### Quick Tips

- To remove all measurements, select **Remove All Measurements**.
- A  symbol appears instead of the expected numerical measurement if a vertical clipping condition exists. Part of the waveform is above or below the display. To obtain a proper numerical measurement, turn the vertical scale and position knobs to make all of the waveform appear in the display.



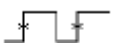

## Selecting Automatic Measurements

The following tables list each automatic measurement by category: time or amplitude. (See page 155, *Taking Automatic Measurements*.)

### Time Measurements

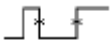
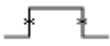
Measurement		Description
Period		The time required to complete the first cycle in a waveform or gated region. Period is the reciprocal of frequency and is measured in seconds.
Frequency		The first cycle in a waveform or gated region. Frequency is the reciprocal of the period; it is measured in hertz (Hz) where one Hz is one cycle per second.
Delay		The time between the mid reference (default 50%) amplitude point of two different waveforms. See also <i>Phase</i> .
Rise Time		The time required for the leading edge of the first pulse in the waveform or gated region to rise from the low reference value (default = 10%) to the high reference value (default = 90%) of the final value.
Fall Time		The time required for the falling edge of the first pulse in the waveform or gated region to fall from the high reference value (default = 90%) to the low reference value (default = 10%) of the final value.
Positive Duty Cycle		The ratio of the positive pulse width to the signal period expressed as a percentage. The duty cycle is measured on the first cycle in the waveform or gated region.

## Time Measurements (cont.)

Measurement		Description
Negative Duty Cycle		The ratio of the negative pulse width to the signal period expressed as a percentage. The duty cycle is measured on the first cycle in the waveform or gated region.
Positive Pulse Width		The distance (time) between the mid reference (default 50%) amplitude points of a positive pulse. The measurement is made on the first pulse in the waveform or gated region.
Negative Pulse Width		The distance (time) between the mid reference (default 50%) amplitude points of a negative pulse. The measurement is made on the first pulse in the waveform or gated region.
Burst Width		The duration of a burst (a series of transient events) and is measured over the entire waveform or gated region.
Phase		The amount of time that one waveform leads or lags another waveform, expressed in degrees where 360° makes up one waveform cycle. See also <i>Delay</i> .

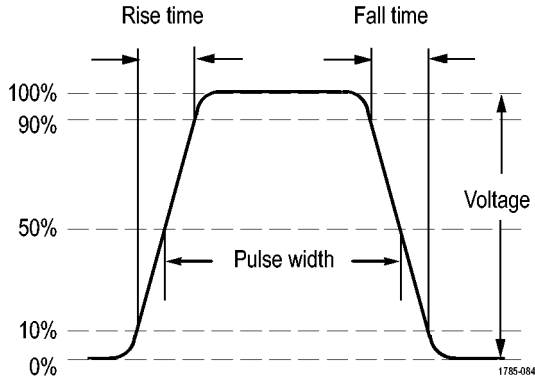

## Amplitude Measurements

### Measurement

### Description

Positive  
Overshoot

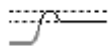







This is measured over the entire waveform or gated region and is expressed as:  
Positive Overshoot =  $(\text{Maximum} - \text{High}) / \text{Amplitude} \times 100\%$ .

Negative  
Overshoot







This is measured over the entire waveform or gated region and is expressed as:  
Negative Overshoot =  $(\text{Low} - \text{Minimum}) / \text{Amplitude} \times 100\%$ .

### Amplitude Measurements (cont.)

Measurement		Description
Pk-Pk		The absolute difference between the maximum and minimum amplitude in the entire waveform or gated region.
Amplitude		The high value less the low value measured over the entire waveform or gated region.
High		This value is used as 100% whenever high reference, mid reference, or low reference values are needed, such as in fall time or rise time measurements. Calculate using either the min/max or histogram method. The min/max method uses the maximum value found. The histogram method uses the most common value found above the midpoint. This value is measured over the entire waveform or gated region.
Low		This value is used as 0% whenever high reference, mid reference, or low reference values are needed, such as in fall time or rise time measurements. Calculate using either the min/max or histogram method. The min/max method uses the minimum value found. The histogram method uses the most common value found below the midpoint. This value is measured over the entire waveform or gated region.
Max		The most positive peak voltage. Max is measured over the entire waveform or gated region.
Min		The most negative peak voltage. Min is measured over the entire waveform or gated region.







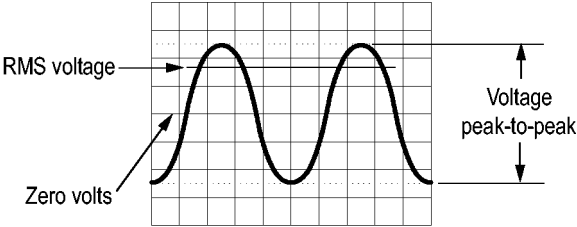

**Amplitude Measurements (cont.)**

Measurement		Description
Mean		The arithmetic mean over the entire waveform or gated region.
Cycle Mean		The arithmetic mean over the first cycle in the waveform or the first cycle in the gated region.
RMS		The true Root Mean Square voltage over the entire waveform or gated region.
Cycle RMS		The true Root Mean Square voltage over the first cycle in the waveform or the first cycle in the gated region.



1785-083

## Miscellaneous Measurements

Measurement		Description
Rising Edge Count		The number of positive transitions from the low reference value to the high reference value in the waveform or gated region.
Falling Edge Count		The number of negative transitions from the high reference value to the low reference value in the waveform or gated region.
Positive Pulse Count		The number of positive pulses that rise above the mid reference crossing in the waveform or gated region.
Negative Pulse Count		The number of negative pulses that fall below the mid reference crossing in the waveform or gated region.
Area		Area measurement is a voltage over time measurement. It returns the area over the entire waveform or gated region in volt-seconds. Area measured above ground is positive; area measured below ground is negative.
Cycle Area		A voltage over time measurement. The measurement is the area over the first cycle in the waveform or the first cycle in the gated region expressed in volt-seconds. The area above the common reference point is positive, and the area below the common reference point is negative.

## Customizing an Automatic Measurement

You can customize automatic measurements by using gating, modifying measurement statistics, adjusting the measurement reference levels, or taking a snapshot.

### Gating

Gating confines the measurement to a certain portion of a waveform. To use:



1. Push **Measure**.



2. Push **More** as many times as needed to select **Gating** from the resulting pop-up menu.



3. Position the gates from the side-bezel menu options.

Gating
 Off (Full Record)
 Screen
 Between Cursors
Bring Cursors On Screen

## Statistics

Statistics characterize the stability of measurements. To adjust statistics:

1. Push **Measure**.



2. Push **More** as many times as needed to select **Statistics** from the resulting pop-up menu.



3. Push the side-bezel menu options. These include whether to turn statistics on or off and how many samples to use for mean and standard deviation calculations.

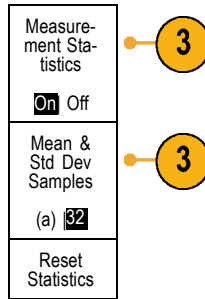

## Snapshot

To see all the single-sourced measurements at one moment in time:

1. Push **Measure**.



2. Push **Add Measurement**, as many times as needed to select **Statistics** from the resulting pop-up menu.

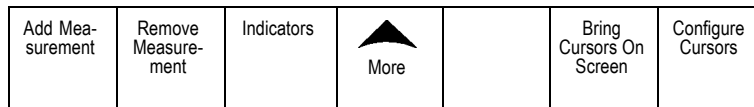

2

3. Turn multipurpose knob **a** to select the **Measurement Type** of **Snapshot**.



4. Push **OK Snapshot All Measurements**.

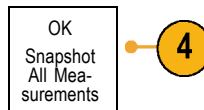

5. View results.

Snapshot on 1

Period	: 312.2 $\mu$ s	Freq	: 3.203kHz
+Width	: 103.7 $\mu$ s	-Width	: 208.5 $\mu$ s
Burst W	: 936.5 $\mu$ s		
Rise	: 1.452 $\mu$ s	Fall	: 1.144 $\mu$ s
+Duty	: 33.23%	-Duty	: 66.77 %
+Over	: 7.143%	-Over	: 7.143 %
High	: 9.200 V	Low	: -7.600 V
Max	: 10.40 V	Min	: -8.800 V
Ampl	: 16.80 V	Pk-Pk	: 19.20 V
Mean	: -5.396 V	CycleMean	: -5.396 V
RMS	: 7.769 V	CycleRMS	: 8.206 V
Area	: -21.58mVs	CycleArea	: -654.6 $\mu$ Vs



## Reference Levels

Reference levels determine how time-related measurements are taken. For example, they are used in calculating rise and fall times.

1. Push **Measure**.



2. Push **More** as many times as needed to select **Reference Levels** from the resulting pop-up menu.

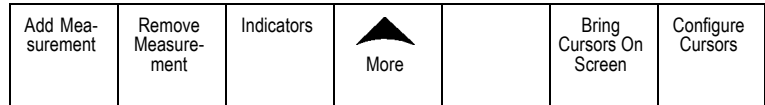

3. Set the levels from the side-bezel menu.

Use High and Low reference to calculate rise and fall times.

Use Mid reference primarily for measurements between edges, such as pulse widths.

Reference Levels
Set Levels in %  Units
High Ref (a) 90.0 %
Mid Ref 50.0 % 50.0 %
Low Ref 10.0 %
- Set to Defaults

## Taking Manual Measurements with Cursors

Cursors are on-screen markers that you position in the waveform display to take manual measurements on acquired data. They appear as horizontal and/or as vertical lines. To use cursors:

### 1. Push **Cursors**.

This changes the cursor state. The three states are:

- No cursors appear on the screen.
- Two vertical waveform cursors appear. They are attached to the selected waveform.
- Four screen cursors appear. Two are vertical and two are horizontal. They are no longer specifically attached to a waveform.

For example, the first time you push **Cursors**, the state might be off.



2. Push **Cursors** again.

In the example, two vertical cursors appear on the selected screen waveform. As you turn multipurpose knob **a**, you move one cursor to the right or left. As you turn knob **b**, you move the other cursor.

If you change the selected waveform by pushing the front-panel **1**, **2**, **3**, **4**, **M**, or **R** button, both cursors jump to the new selected waveform.

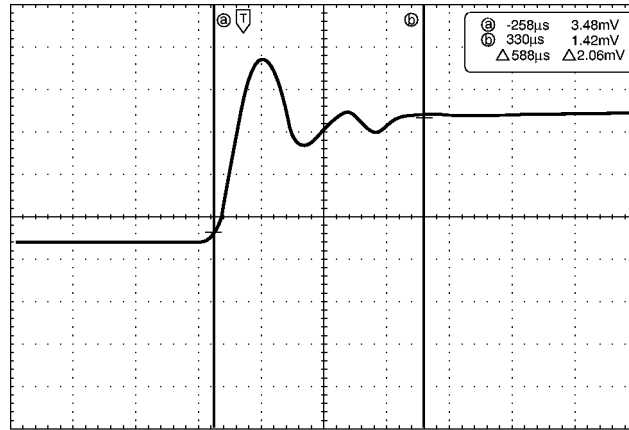

1785-146

3. Push **Select**.

This turns the cursor linking on and off. If linking is on, turning multipurpose knob **a** moves the two cursors together. Turning multipurpose knob **b** adjusts the time between the cursors.



2410-047

4. Push **Fine** to toggle between a coarse and a fine adjustment for multipurpose knobs **a** and **b**.

Pushing **Fine** also changes the sensitivity of other knobs as well.



5. Push **Cursors** again.

This will put the cursors into screen mode. Two horizontal bars and two vertical bars span the graticule.



- Turn multipurpose knobs **a** and **b** to move the pair of horizontal cursors.



- Push **Select**.

This makes the horizontal cursors active and the vertical ones inactive. Now, as you turn the multipurpose knobs, the horizontal cursors will move.

Push **Select** again to make the vertical cursors active again.



8. View the cursor and the cursor readout.  
You can take timing measurements with cursors on digital channels, but not amplitude measurements.

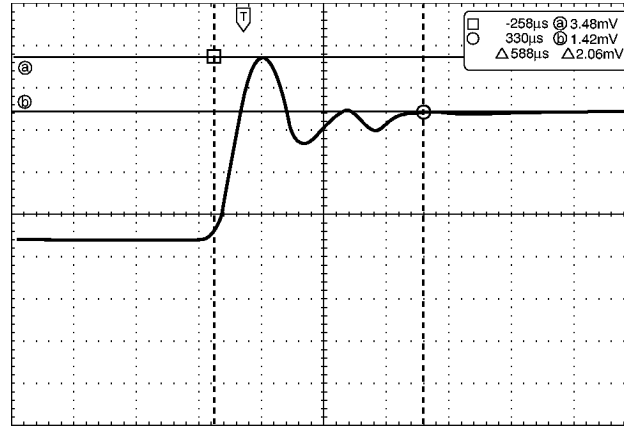

1785-147

9. Push **Cursors** again. This will turn off the cursor mode. The screen will no longer display the cursors and the cursor readout.



2410-066

## Using Cursor Readouts

Cursor readouts supply textual and numeric information relating to the current cursor positions. The oscilloscope always shows the readouts when the cursors are turned on.

Readouts appear in the upper right corner of the graticule. If Zoom is on, the readout appears in the upper right corner of the zoom window.

When a bus is selected, the readout shows the decoded bus data in the format you have selected, hexadecimal, binary, decimal, or ASCII (depending on the selected standard). The data value of that point is displayed in the cursor readout.

### $\Delta$ Readout:

The  $\Delta$  readouts indicate the difference between the cursor positions.

### a Readout:

Indicates that the value is controlled by multipurpose knob **a**.

### b Readout:

Indicates that the value is controlled by multipurpose knob **b**.

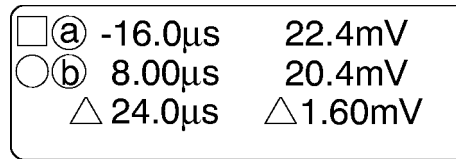

1785-134



The horizontal cursor lines on the display measure the vertical parameters, typically voltage.

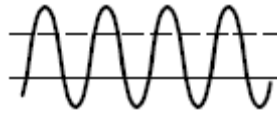

The vertical cursor lines on the display measure horizontal parameters, typically time.



The square and circle shapes in the readout map to the multipurpose knobs when both vertical and horizontal cursors are present.

## Using XY Cursors

When the XY Display mode is on, the cursor readouts will appear to the right of the graticule. They include rectangular, polar, product, and ratio readouts.

## Using Math Waveforms

Create math waveforms to support the analysis of your channel and reference waveforms. By combining and transforming source waveforms and other data into math waveforms, you can derive the data view that your application requires.

**NOTE.** Math waveforms are not available for use with serial buses.

Use the following procedure for executing simple (+, -, \*, ÷) math operations on two waveforms:

1. Push **Math**.

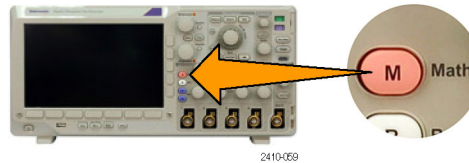

2. Push **Dual Wfm Math**.



3. On the side-bezel menu, set the sources to either channel **1, 2, 3, 4**, or reference waveforms **R1, R2, R3, or R4**. Choose the **+**, **-**, **x**, or **÷** operators.

4. For example, you might calculate power by multiplying a voltage waveform and a current waveform.

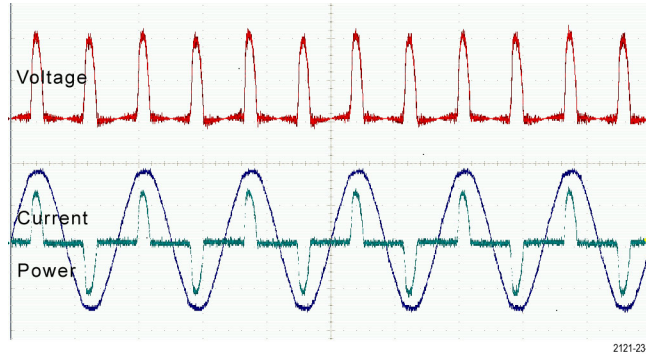

## Quick Tips

- Math waveforms can be created from channel or reference waveforms or a combination of them.
- Measurements can be taken on math waveforms in the same way as on channel waveforms.
- Math waveforms derive their horizontal scale and position from the sources in their math expressions. Adjusting these controls for the source waveforms also adjusts the math waveform.
- You can zoom in on math waveforms using the inner knob of the Pan-Zoom control. Use the outer knob for positioning the zoomed area. (See page 189, *Using Wave Inspector to Manage Long Record Length Waveforms.*)

## Using FFT

An FFT breaks down signals into component frequencies, which the oscilloscope uses to display a graph of the frequency domain of a signal, as opposed to the oscilloscope's standard time domain graph. You can match these frequencies with known system frequencies, such as system clocks, oscillators, or power supplies.

1. Push **Math**.

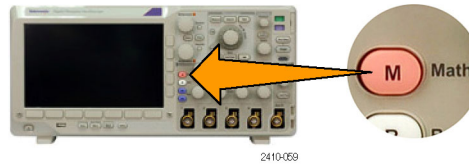

2. Push **FFT**.



3. Push the side-bezel menu **FFT Source** button, if needed, and turn multipurpose knob **a** to select the source to use. Choices are: channels 1, 2, 3, 4, reference waveforms R1, R2, R3, and R4.
4. Push the side-bezel **Vertical Scale** button repeatedly to select either Linear RMS or dBV RMS.
5. Push the side-bezel **Window** button repeatedly to select the desired window. Window choices are: Rectangular, Hamming, Hanning, and Blackman-Harris.
6. Push the side-bezel **Horizontal** button to activate multipurpose knobs **a** and **b** to pan and zoom the FFT display.

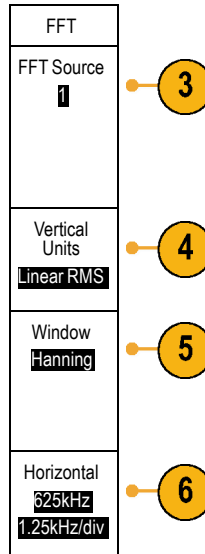

7. The FFT will appear on the display.

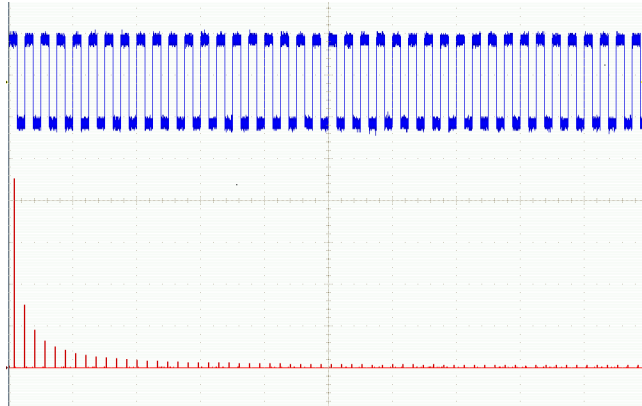

### Quick Tips

- Use short record lengths for faster instrument response.
- Use long record lengths to lower the noise relative to the signal and increase the frequency resolution.
- If desired, use the zoom feature along with the horizontal **Position** and **Scale** controls to magnify and position the FFT waveform.
- Use the default dBV RMS scale to see a detailed view of multiple frequencies, even if they have very different amplitudes. Use the linear RMS scale to see an overall view of how all frequencies compare to each other.

- The FFT feature provides four windows. Each is a trade-off between frequency resolution and magnitude accuracy. What you want to measure and your source signal characteristics help determine which window to use. Use the following guidelines to select the best window.

---

**Description**
**Window**
**Rectangular**

This is the best type of window for resolving frequencies that are very close to the same value but worst for accurately measuring the amplitude of those frequencies. It is the best type for measuring the frequency spectrum of nonrepetitive signals and measuring frequency components near DC.

Use Rectangular for measuring transients or bursts where the signal level before and after the event are nearly equal. Also, use this window for equal-amplitude sine waves with frequencies that are very close and for broadband random noise with a relatively slow varying spectrum.

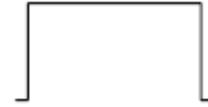
**Hamming**

This is a very good window for resolving frequencies that are very close to the same value with somewhat improved amplitude accuracy over the rectangular window. It has a slightly better frequency resolution than the Hanning.

Use Hamming for measuring sine, periodic, and narrow band random noise. This window works on transients or bursts where the signal levels before and after the event are significantly different.

**Hanning**

This is a very good window for measuring amplitude accuracy but less so for resolving frequencies.

Use Hanning for measuring sine, periodic, and narrow band random noise. This window works on transients or bursts where the signal levels before and after the event are significantly different.



**Description**

**Blackman-Harris:**

This is the best window for measuring the amplitude of frequencies but worst at resolving frequencies.

Use Blackman-Harris for measuring predominantly single frequency waveforms to look for higher order harmonics.

**Window**



## Using Advanced Math

The advanced math feature lets you create a custom math waveform expression that can incorporate active and reference waveforms, measurements, and/or numeric constants. To use this feature:

1. Push **Math**.

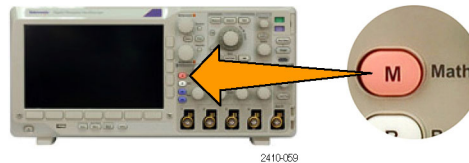



2. Push **Advanced Math**.



3. Use the side-bezel menu buttons to create custom expressions.

4. Push **Edit Expression** and use the multipurpose knobs and the resulting lower-bezel buttons to create an expression. When done, push the side-bezel menu **OK Accept** button.

For example, to use **Edit Expression** to take the integral of a square wave:

1. Push the lower-bezel **Clear** button.
2. Turn multipurpose knob **a** to select **Intg(**.
3. Push **Enter Selection**.
4. Turn multipurpose knob **a** to select channel 1.
5. Push **Enter Selection**.
6. Turn multipurpose knob **a** to select **)**.
7. Push **OK Accept**.

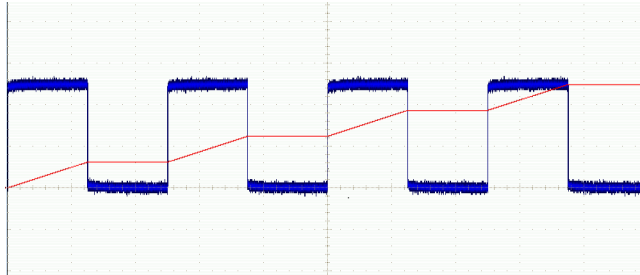

## Using Reference Waveforms

Create a reference waveform to store a waveform. For example, you might do this to set up a standard against which to compare other waveforms. To use the reference waveforms:

---

**NOTE.** 5 M reference waveforms are volatile and not saved when the oscilloscope power is turned off. To keep these waveforms, save them to external storage.

---

1. Push **Ref R**. This brings up the lower-bezel reference menu.

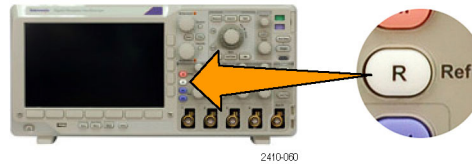

2. Use the resulting lower-bezel menu selections to display or select a reference waveform.

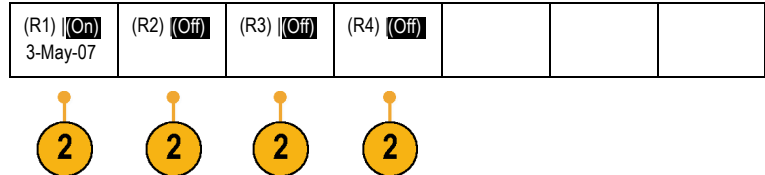

- Use the side-bezel menu and the multipurpose knobs to adjust the vertical and horizontal settings of the reference waveform.

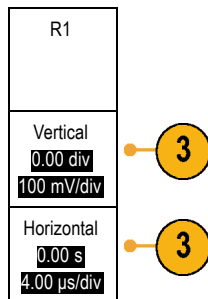

## Quick Tips

- **Selecting and Displaying Reference Waveforms.** You can display all the reference waveforms at the same time. Push the appropriate screen button to select a particular reference waveform.
- **Removing Reference Waveforms from the Display.** To remove a reference waveform from the display, push the front-panel **R** button to access the lower-bezel menu. Then push the associated button from the lower-bezel menu to turn it off.
- **Scaling and Positioning a Reference Waveform.** You can position and scale a reference waveform independently from all other displayed waveforms. Select the reference waveform and then adjust it with a multipurpose knob. You can do this whether acquisition is running or not.

If a reference waveform is selected, scaling and repositioning of the reference waveform operates the same way whether zoom is turned on or off.

- **Saving 5 M Reference Waveforms.** 5 M reference waveforms are volatile and not saved when the oscilloscope power is turned off. To keep these waveforms, save them to external storage.

## Using Wave Inspector to Manage Long Record Length Waveforms

The Wave Inspector controls (zoom/pan, play/pause, marks, search) help you to efficiently work with long record length waveforms. To magnify a waveform horizontally, turn the Zoom knob. To scroll through a zoomed waveform, turn the Pan knob.

The Pan-Zoom Control consists of:

1. An outer pan knob
2. An inner zoom knob

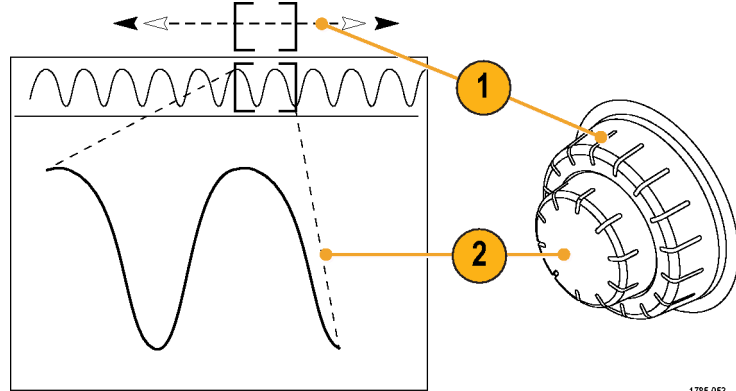

1785-053

## Zooming a Waveform

To use zoom:

1. Rotate the inner knob on the Pan-Zoom control clockwise to zoom in on a selected portion of the waveform. Rotate the knob counterclockwise to zoom back out.

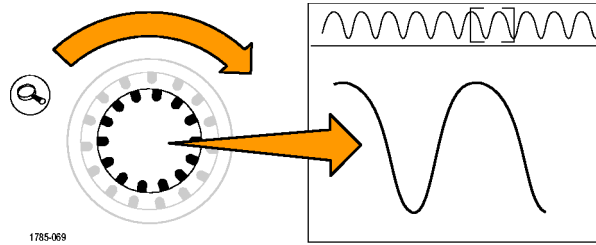

2. Alternatively, enable or disable the zoom mode by pushing the zoom button.

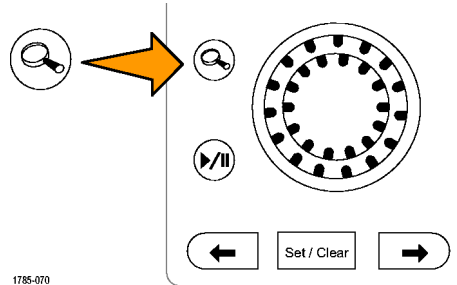

3. Examine the zoomed view of the waveform that appears on the larger, lower portion of the display. The upper portion of the display will show the position and size of the zoomed portion in the waveform, within the context of the overall record.

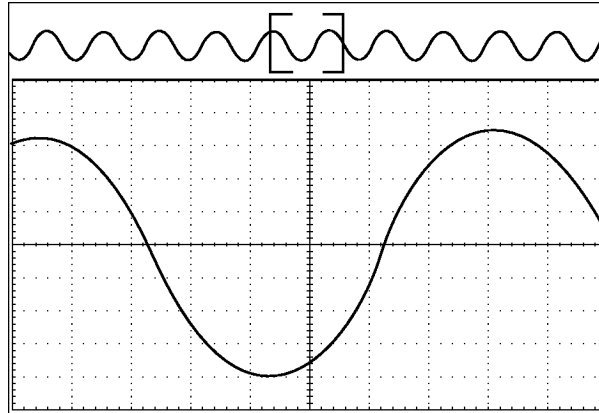

1785-154

## Panning a Waveform

While the zoom feature is on, you can use the pan feature to quickly scroll through the waveform. To use pan:

1. Rotate the pan (outer) knob of the pan-zoom controls to pan the waveform.  
Turn the knob clockwise to pan forward. Turn it counterclockwise to pan backwards. The further you turn the knob, the faster the zoom window pans.

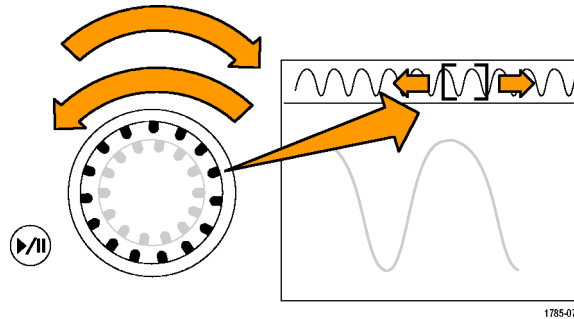

### Playing and Pausing a Waveform

Use the play-pause feature to automatically pan through a waveform record. To use it:



1. Enable the play-pause mode by pushing the play-pause button.
2. Adjust the play speed by turning the pan (outer) knob further. The further you turn it, the faster it goes.

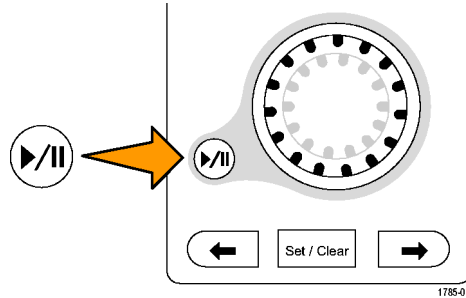

3. Change the play direction by reversing the direction that you are turning the pan knob.
4. During play, up to a point, the more you turn the ring, the faster the waveform accelerates. If you rotate the ring as far as it can go, the play speed does not change, but the zoom box quickly moves in that direction. Use this maximum rotation feature to replay a portion of the waveform that you just saw and want to see again.

5. Pause the play-pause feature by pushing the play-pause button again.

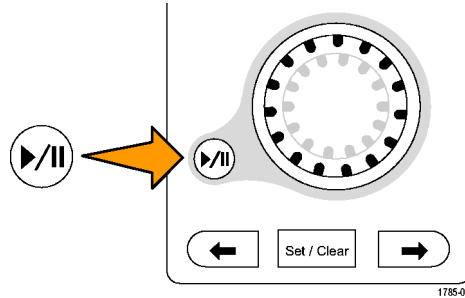

## Searching and Marking Waveforms

You can mark locations of interest in the acquired waveform. These marks help you limit your analysis to particular regions of the waveform. You can mark areas of the waveform automatically, if they meet some special criteria, or you can manually mark each item of interest. You can use arrow keys to jump from mark to mark (area of interest to area of interest). You can automatically search and mark many of the same parameters that you can trigger on.

Search marks provide a way to mark a waveform region for reference. You can set marks automatically with search criteria. You can search for and mark regions with particular edges, pulse widths, runts, logic states, rise/fall times, setup and hold, and bus search types.

To manually set and clear (delete) marks:

1. Move (the zoom box) to the area on the waveform where you want to set (or clear) a search mark by turning the pan (outer) knob.

Push the next (→) or previous (←) arrow button to jump to an existing mark.

2. Push **Set/Clear**.

If no search mark is at the screen center, the oscilloscope will add one.

3. Investigate your waveform by moving from search mark to search mark. Use the next (→) or previous (←) arrow button to jump from one marked location to another, without adjusting any other controls.

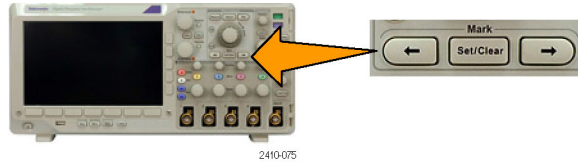

4. Delete a mark. Push the next (→) or previous (←) arrow button to jump to the mark you want to clear. To remove the current, center-positioned mark, push **Set/Clear**. It works on both manually and automatically created marks.

To automatically set and clear (delete) search marks:

1. Push **Search**.



2. Select the search type desired from the lower-bezel menu.

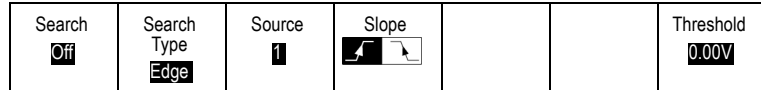

The search menu is similar to the trigger menu.



3. From the side-bezel menu, turn on the search.

4. On the screen, hollow triangles show the location of automatic marks and solid triangles show the custom (user-defined) locations. These appear on both normal and zoomed waveform views.
5. You can quickly investigate your waveform by moving from search mark to search mark with the next (→) and previous (←) arrow buttons. No other adjustments are needed.

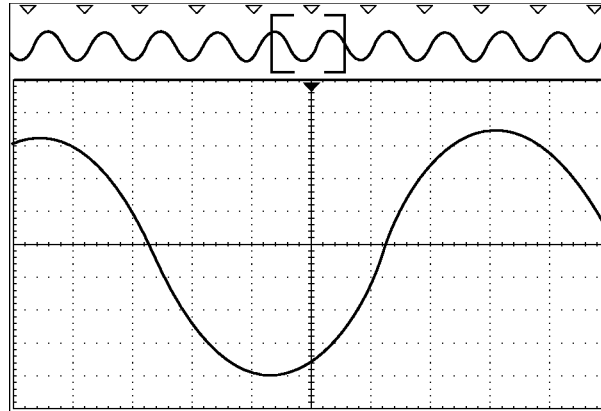

### Quick Tips.

- You can copy trigger settings to search for other locations in your acquired waveform that meet the trigger conditions.
- You can also copy search settings to your trigger.
- Custom (User) marks are saved with the waveform when the waveform is saved and when the setup is saved.
- Automatic search marks are not saved with the waveform when the waveform is saved. However, you can easily recapture them by reusing the search function.
- The search criteria are saved in the saved setup.

The Wave Inspector includes the following search capabilities:

Search	Description
Edge	Searches for edges (rising or falling) with a user-specified threshold level.
Pulse Width	Searches for positive or negative pulse widths that are $>$ , $<$ , $=$ , or $\neq$ a user specified pulse width.
Runt	Searches for positive or negative pulses that cross one amplitude threshold but fail to cross a second threshold before crossing the first again. Search for all runt pulses or only those with a duration $>$ , $<$ , $=$ , or $\neq$ a user specified time.
Logic	Search for a logic pattern (AND, OR, NAND, or NOR) across multiple waveforms with each input set to either High, Low, or Don't Care. Search for when the event goes true, goes false, or stays valid for $>$ , $<$ , $=$ , or $\neq$ a user specified time. Additionally, you can define one of the inputs as a clock for synchronous (state) searches.
Setup & Hold	Search for violations of user specified Setup and Hold times.
Rise/Fall Time	Search for rising and/or falling edges that are $>$ , $<$ , $=$ , or $\neq$ a user specified time.
Bus	I <sup>2</sup> C: Search for Start, Repeated Start, Stop, Missing Ack, Address, Data, or Address and Data. SPI: Search for SS Active, MOSI, MISO, or MOSI & MISO CAN: Search for Start of Frame, Type of Frame (Data, Remote, Error, Overload), Identifier (standard or extended), Data, Identifier and Data, End of Frame, or Missing Ack, Bit Stuffing Error RS-232, RS-422, RS-485, UART: Search for Tx Start Bit, Rx Start Bit, Tx End of Packet, Rx End of Packet, Tx Data, Rx Data, Tx Parity Error, Rx Parity Error. LIN: Search for Synch, Identifier, Data, ID & Data, Wakeup Frame, Sleep Frame, Error

## Save and Recall Information

The oscilloscope provides permanent storage for setups, waveforms, and screen images. Use the internal storage of the oscilloscope to save setup files and reference waveform data.

Use external USB flash drives, to save setups, waveforms, and screen images. Use the external storage to carry data to remote computers for further analysis and for archiving.

**External File Structure.** If you are saving information to external storage, select the appropriate menu (such as the **To File** side-bezel menu to save setups and waveforms) and turn multipurpose knob **a** to scroll through the external file structure.

- E: is the USB flash drive plugged into the USB port on the front of the oscilloscope
- F: is the USB flash drive plugged into the USB port on the rear of the oscilloscope

Use multipurpose knob **a** to scroll through the list of files. Use the **Select** front panel button to open and close folders.

**Naming Your File.** The oscilloscope gives all files it creates a default name in the following format:

- tekXXXXX.set for setup files where XXXXX is an integer from 00000 to 99999
- tekXXXXX.png, tekXXXXX.bmp, or tekXXXXX.tif for image files
- tekXXXXYYYY.csv for spreadsheet files or tekXXXXYYYY.isf for internal format files

For waveforms, the XXXX is an integer from 0000 to 9999. The YYY is the channel of the waveform, and can be one of the following:

- CH1, CH2, CH3, or CH4 for the analog channels
- MTH for a math waveform

- RF1, RF2, RF3, or RF4 for reference memory waveforms
- ALL for a single spreadsheet file containing multiple channels when you select Save All Waveforms

---

**NOTE.** Only analog channels and waveforms derived from analog channels (such as math and reference) can be saved to an ISF file. When saving all channels in ISF format, a group of files will be saved. Each will have the same value for XXXX, but the YYY values will be set to the different channels that were turned on when the Save All Waveforms was performed.

---

For example, the first time you save a file, that file is named tek00000. The next time you save the same type of file, the file will be named tek00001.

**Editing File, Directory, Reference Waveform, or Instrument Setup Names.** Give files descriptive names that you can recognize at a later date. To edit file names, directory names, reference waveform and instrument setup labels:

1. Push **Save / Recall Menu**.

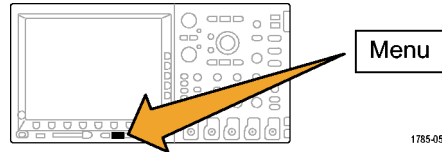



2. Push **Save Screen Image**, **Save Waveform**, or **Save Setup**.

Save Screen Image	Save Waveform	Save Setup	Recall Waveform	Recall Setup	Assign Save to Setup	File Utilities
-------------------	---------------	------------	-----------------	--------------	----------------------------	----------------



3. For waveform or setup files, enter the file manager by pushing the side-bezel menu **To File** item.



4. Turn multipurpose knob **a** to scroll through the file structure. (See page 199, *External File Structure*.)



2410-045

5. Push **Select** to open or close file folders.



6. Push **Edit File Name**.

Edit the file name the same way you edit labels for channels. (See page 79, *Labeling Channels and Buses.*)

7. Push the **Menu Off** button to cancel the save operation, or push a side-bezel menu **OK Save** item to complete the operation.



## Saving a Screen Image

A screen image consists of a graphical image of the oscilloscope screen. This is different from waveform data, which consists of numeric values for each point in the waveform. To save a screen image:

1. Push **Save / Recall Menu**.

Do not yet push the **Save** button.

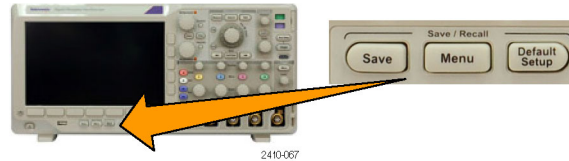

2. Push **Save Screen Image** from the lower-bezel menu.

Save Screen Image	Save Waveform	Save Setup	Recall Waveform	Recall Setup	Assign <b>Save</b> to <b>Setup</b>	File Utilities
-------------------	---------------	------------	-----------------	--------------	------------------------------------	----------------



3. From the side-bezel menu, push **File Format** repeatedly to select among: .tif, .bmp, and .png formats.

Save Screen Image
File Format <b>png</b>

4. Push **Orientation** to select between saving the image in a landscape (horizontal) and a portrait (vertical) orientation.
5. Push **Ink Saver** to turn the **Ink Saver** mode on or off. When on, this mode provides a white background.
6. Push **Edit File Name** to create a custom name for the screen image file. Skip this step to use a default name.
7. Push **OK Save Screen Image** to write the image to the selected media.

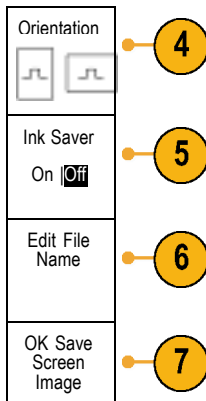

For information on printing screen images of waveforms, go to *Printing a Hard Copy*. (See page 214, *Printing a Hard Copy*.)

## Saving and Recalling Waveform Data

Waveform data consists of the numeric values for each point in the waveform. It copies the data, as opposed to a graphical image of the screen. To save the current waveform data or to recall previously stored waveform data:

1. Push **Save / Recall Menu**.

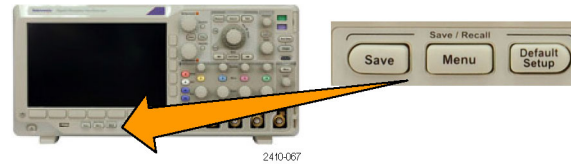

2. Push **Save Waveform** or **Recall Waveform** from the lower-bezel menu.

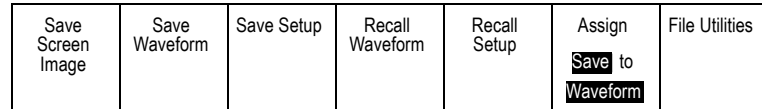

**NOTE.** The oscilloscope can save digital waveforms to .csv files, not reference memories. The oscilloscope cannot recall digital waveforms.

3. Select one waveform or all waveforms.
4. From the resulting side-bezel menu, select the location to save the waveform data to or to recall it from.

Save the information externally to a file on a USB flash drive. Alternatively, save the information internally to one of the two reference memory files on 2-channel model or one of the four reference files on 4-channel model oscilloscopes.

5. Push **File Details** to save to a USB flash drive.



This brings up the file manager screen. Use it to define a custom file name. Skip this step to use the default name and location.

**Saving a Waveform to File.** When you push the **File Details** side-bezel menu button, the oscilloscope changes the side-bezel menu contents. The following table describes these side-bezel menu items for saving data to a mass storage file.

Side-bezel menu button	Description
Internal File Format (.ISF)	Sets the oscilloscope to save waveform data from analog channels (and math and reference waveforms derived from analog channels), in internal waveform save file (.isf) format. This format is the fastest to write and creates the smallest-sized file. Use this format if you intend to recall a waveform to reference memory for viewing or measuring. The oscilloscope cannot save digital waveforms in an .isf file format.
Spreadsheet File Format (.CSV)	Sets the oscilloscope to save waveform data as a comma-separated data file compatible with popular spreadsheet programs. This file cannot be recalled to reference memory.

**Saving an Analog Waveform to Reference Memory.** To save an analog waveform to nonvolatile memory inside the oscilloscope, select the waveform that you want to save, push the **Save Waveform** screen button, and then select one of the reference waveform locations. Four-channel models have four reference locations. Two-channel models have two reference locations.

Saved waveforms contain only the most recent acquisition. Gray-scale information, if any, is not saved.

---

**NOTE.** 5 M reference waveforms are volatile and not saved when the oscilloscope power is turned off. To keep these waveforms, save them to external storage.

---

**Displaying a Reference Waveform.** To display a waveform stored in nonvolatile memory:

1. Push **Ref R**.

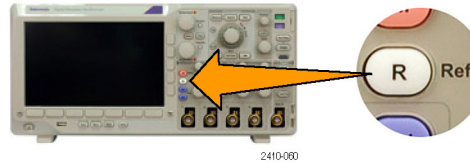

2. Push **R1, R2, R3, or R4**.

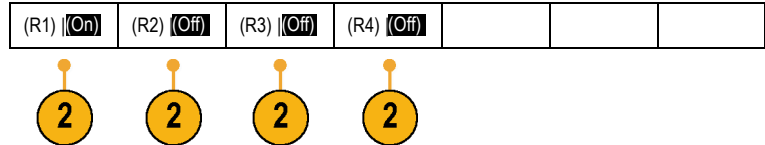

**Removing a Reference Waveform from the Display.** To remove a reference waveform from the display:

1. Push **Ref R**.

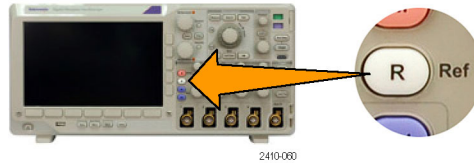

2. Push the **R1**, **R2**, **R3**, or **R4** lower-bezel button to remove the reference waveform from the display.

(R1) <b>(On)</b>	(R2) <b>(Off)</b>	(R3) <b>(Off)</b>	(R4) <b>(Off)</b>			
------------------	-------------------	-------------------	-------------------	--	--	--

The reference waveform is still in nonvolatile memory and can be displayed again.



## Saving and Recalling Setups

Setup information includes acquisition information, such as vertical, horizontal, trigger, cursor, and measurement information. It does not include communications information, such as GPIB addresses. To save the setup information:

1. Push **Save / Recall Menu**.

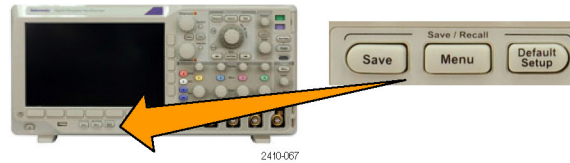

2. Push **Save Setup** or **Recall Setup** from the lower-bezel menu.

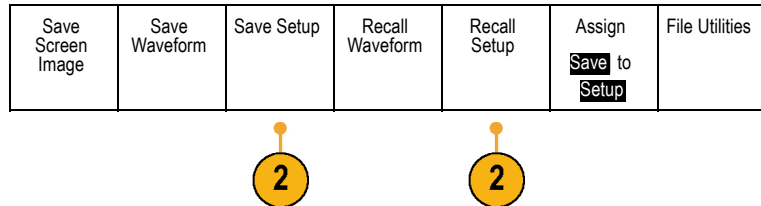

3. From the resulting side-bezel menu, select the location to save the setup to or to recall it from. To save setup information to one of the ten internal setup memories in the oscilloscope, push the appropriate side-bezel button. To save setup information to a USB file, push the **To File** button.

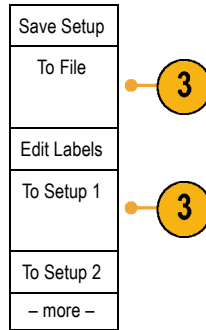

4. If you are saving information to a USB flash drive, turn multipurpose knob **a** to scroll through the file structure. (See page 199, *External File Structure*.)



Push **Select** to open or close file folders.



Push the **Menu Off** button to cancel the save operation, or push a side-bezel menu **Save to Selected File** item to complete the operation.



5. Save the file.



## Quick Tips

- **Recalling the Default Setup.** Push the front-panel **Default Setup** button to initialize the oscilloscope to a known setup. (See page 83, *Using the Default Setup*.)

## Saving with One Button Push

After you have defined the save/recall parameters with the Save/Recall Menu button and menu, you can save files with a single push of the **Save** button. For example, if you have defined the save operation to save waveform data to a USB drive, then each push of the **Save** button will save current waveform data to the defined USB drive.

1. To define the Save button behavior, push **Save/Recall Menu**.

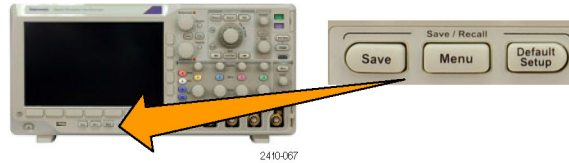

2. Push **Assign Save to** button.

Save Screen Image	Save Waveform	Save Setup	Recall Waveform	Recall Setup	Assign <b>Save to Setup</b>	File Utilities
-------------------	---------------	------------	-----------------	--------------	-----------------------------	----------------



3. Push the action to assign to the **Save** button.

Assign Save to
Screen Image
Waveform
Setup

4. From now on, when you push **Save** the oscilloscope will perform the action that you just specified rather than requiring you to navigate through the menus each time.



## Printing a Hard Copy

To print an image of what appears on the oscilloscope screen, do the following procedure.

### Connect a Printer to Your Oscilloscope

Connect your printer to a USB port on the rear or front panel of the oscilloscope.

Alternatively, you can print to networked printers through the Ethernet port.

### Set Up Print Parameters

To set up the oscilloscope to print hard copies:

1. Push **Utility**.



2. Push **Utility Page**.

Utility Page
--------------



3. Turn multipurpose knob **a** and select **Print Setup**.

Print Setup
-------------

4. Push **Select Printer** if you are changing the default printer.

Utility Page Print Setup	Select Printer ???	Orientation Landscape	Ink Saver On			
-----------------------------	-----------------------	--------------------------	-----------------	--	--	--

Turn multipurpose knob **a** to scroll through the list of available printers.

Push **Select** to choose the desired printer.

To add a USB printer to the list, plug the printer into the USB port. The oscilloscope will automatically recognize most printers.

To add an Ethernet printer to the list, refer to the next topic. (See page 217, *Printing Over Ethernet*.)



5. Select the image orientation (portrait or landscape).

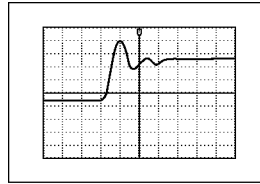

2121-237

Landscape

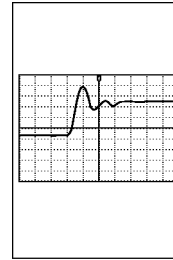

1785-116b

Portrait

6. Choose **Ink Saver On** or **Off**.

The **On** selection will print out a copy with a clear (white) background.



1785-145a

Ink Saver on

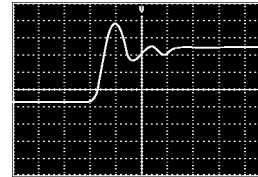

1785-145b

Ink Saver off



## Printing Over Ethernet

To set up the oscilloscope to print over Ethernet:

1. Connect an Ethernet cable to the rear-panel Ethernet port.

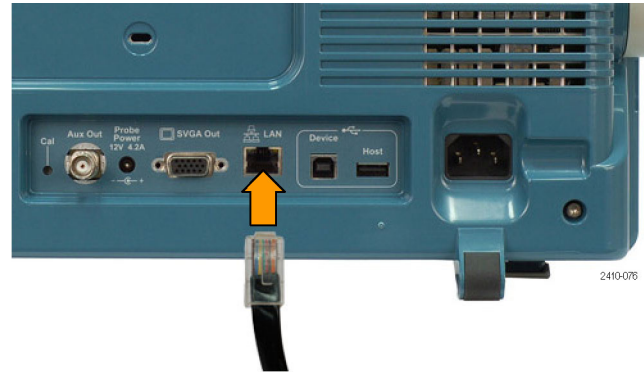

2. Push **Utility**.



3. Push **Utility Page**.

Utility Page



4. Turn multipurpose knob **a** and select **Print Setup**.

Print Setup

5. Push **Select Printer**.

Utility Page Print Setup	Select Printer ???	Orientation Landscape	Ink Saver Off			
-----------------------------	-----------------------	--------------------------	------------------	--	--	--



6. Push **Add Network Printer**.

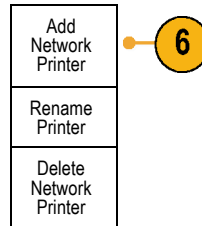

7. Turn multipurpose knob **a** to scroll through the list of letters, numbers, and other characters to find the first character in the printer name that you want to enter.

If you are using a USB keyboard, use the arrow keys to position the insertion point and type in the printer name. (See page 48, *Connecting a USB Keyboard to Your Oscilloscope*.)



2410.045

ABCDEFGHIJKLMNOPQRSTUVWXYZ  
 abcdefghijklmnopqrstuvwxyz  
 0123456789\_+-.!@#\$\$%^&\*()[]{}<>/~`"'.:;?`

- Push **Select** or **Enter Character** to let the oscilloscope know that you have picked the proper character to use.



2410-047

You can use the lower-bezel buttons to edit the name, as needed.

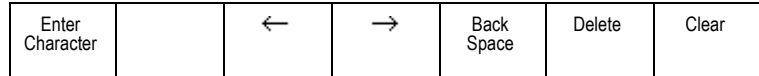

- Continue scrolling and pushing **Select** until you have entered all the desired characters.

- Push the down arrow key to move the character cursor down a row to the **Server Name** field.
- Turn multipurpose knob **a** and push **Select** or **Enter Character** as often as needed to enter the name.

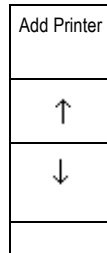

12. If desired, push the down arrow key to move the character cursor down a row to the **Server IP Address:** field.

OK Accept

13. Turn multipurpose knob **a** and push **Select** or **Enter Character** as often as needed to enter the name.
14. When done, push **OK Accept**.

**NOTE.** *If you have multiple printers connected to the oscilloscope at the same time, the oscilloscope will print to the printer listed in the Utility> Utility Page> Print Setup> Select Printer menu item.*

## Printing with One Button Push

Once you have connected a printer to your oscilloscope and set up print parameters, you can print current screen images with a single push of a button:

Push the printer icon button in the lower left corner of the front panel.



## Erasing Oscilloscope Memory

You can erase all setup and waveform information saved in the nonvolatile oscilloscope memory with the TekSecure function. If you have acquired confidential data on your oscilloscope, you may want to execute the TekSecure function before you return the oscilloscope to general use. The TekSecure function:

- Replaces all waveforms in all reference memories with null values
- Replaces the current front-panel setup and all stored setups with the default setup
- Displays a confirmation or warning message, depending on whether the verification is successful or unsuccessful

To use TekSecure:

1. Push **Utility**.



2. Push **Utility Page**.

Utility Page



3. Turn multipurpose knob **a** and select **Config**.

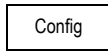

4. Push **TekSecure Erase Memory**.

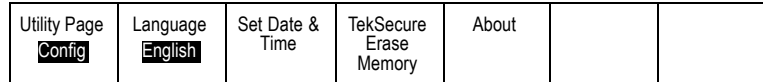

5. Push **OK Erase Setup and Ref Memory** from the side-bezel menu.

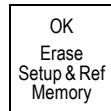

To cancel the procedure, push **Menu Off**.



2410-028



6. Power off the oscilloscope, and then power it back on to complete the process.



## Using Application Modules

Optional application module packages extend the capability of your oscilloscope. (See page 24, *Application Module Free Trial*.) You can install up to four application modules at one time. (See page 25, *Installing an Application Module*.)

Refer to the *DPO3000 Series Oscilloscopes Application Module Installation Instructions* that came with your application module for instructions on installing and testing an application module. Some modules are described in the following list. Additional modules may be available. Contact your Tektronix representative or visit our Web site at [www.tektronix.com](http://www.tektronix.com) for more information. Also, refer to *Contacting Tektronix* at the beginning of the manual.

- The **DPO3EMBD Embedded Serial Triggering and Analysis Module** adds triggering on packet level information in serial buses used in embedded designs (I<sup>2</sup>C and SPI), as well as analytical tools to help you efficiently analyze your serial bus. These include digital views of the signal, bus views, packet decoding, search tools, and event tables with timestamp information.
- The **DPO3AUTO Automotive Serial Triggering and Analysis Module** adds triggering on packet level information in serial buses used in automotive designs (CAN and LIN), as well as analytical tools to help you efficiently analyze your serial bus. These include digital views of the signal, bus views, packet decoding, search tools, and event tables with timestamp information.
- The **DPO3COMP Computer Serial Triggering and Analysis Module** adds triggering on byte or packet level information in RS-232, RS-422, RS-485, and UART buses, and analytical tools to help you efficiently analyze your serial bus. These include digital views of the signal, bus views, packet decoding, search tools, and event tables with timestamp information.
- The **DPO3VID Extended Video Module** adds triggering on a variety of standard HDTV signals, as well as on custom (non-standard) bilevel and trilevel video signals with 3 to 4,000 lines.

## Application Examples

This section contains ways to use your instrument in both common and advanced troubleshooting tasks.

### Taking Simple Measurements

If you need to see a signal in a circuit, but you do not know the signal amplitude or frequency, connect the probe from channel 1 of the oscilloscope to the signal. Then display the signal and measure its frequency and peak-to-peak amplitude.

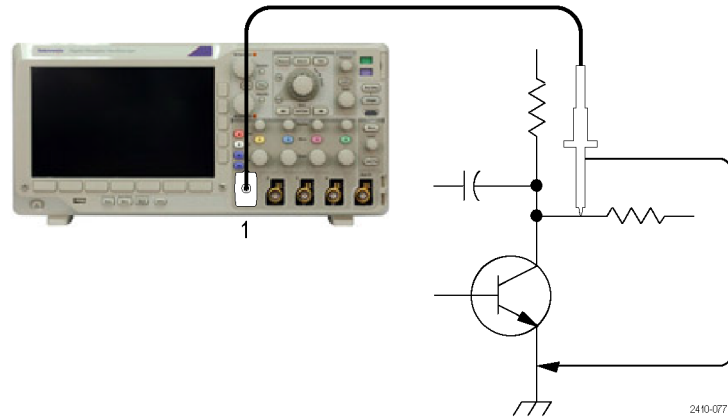

## Using Autoset

To quickly display a signal:

1. Push **Autoset**.



The oscilloscope sets vertical, horizontal, and trigger controls automatically. You can manually adjust any of these controls if you need to optimize the display of the waveform.

When you are using more than one channel, the autoset function sets the vertical controls for each channel and uses the lowest-numbered active channel to set the horizontal and trigger controls.

## Selecting Automatic Measurements

The oscilloscope can take automatic measurements of most displayed signals. To measure signal frequency and peak-to-peak amplitude:

1. Push **Measure**.



2. Push **Add Measurement**.



3. Turn multipurpose knob **a** to select the **Frequency** measurement. If needed, press **Source** from the side menu and turn multipurpose knob **b** to select the channel from which you want to measure. Push **OK Add Measurement** from the side menu. Repeat this process to select the **Peak-to-peak** measurement.



4. Push **Menu Off**.



5. Observe that the measurements appear on the screen and update as the signal changes.

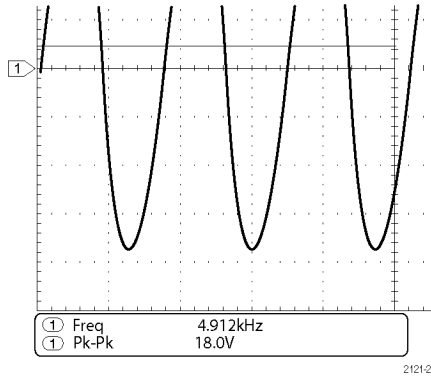

## Measuring Two Signals

In this example, you are testing a piece of equipment and need to measure the gain of its audio amplifier. You have an audio generator that can inject a test signal at the amplifier input. Connect two oscilloscope channels to the amplifier input and output as shown. Measure both signal levels and use these measurements to calculate the gain.

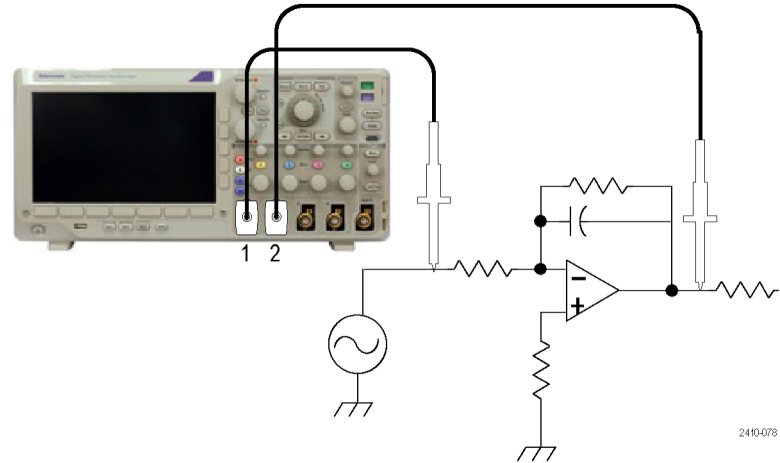

To display the signals connected to channels 1 and 2:

1. Push channel 1 and channel 2 to activate both channels.

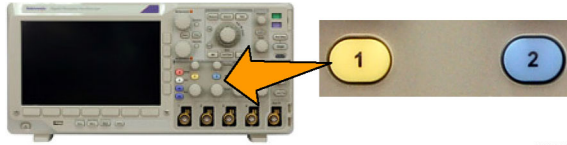

2410-043

2. Push **Autoset**.



2410-008

To select measurements for the two channels:

1. Push **Measure** to see the measurement menu.



2410-055



2. Push **Add Measurement**.



3. Turn multipurpose knob **a** to select the **Amplitude** measurement from the side menu. If needed, press **Source** and turn multipurpose knob **b** to select channel 1. Push **OK Add Measurement** from the side menu. Repeat this process to select channel 2 and again push **OK Add Measurement** from the side menu.



2410/045

4. Calculate the amplifier gain using the following equations:

$$\text{Gain} = (\text{output amplitude} \div \text{input amplitude}) = (3.155 \text{ V} \div 130.0 \text{ mV}) = 24.27$$

$$\text{Gain (dB)} = 20 \times \log(24.27) = 27.7 \text{ dB}$$

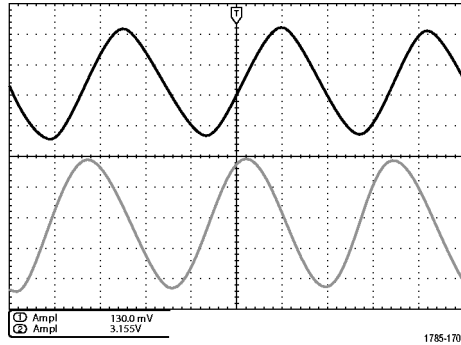

## Customizing Your Measurements

In this example, you want to verify that the incoming signal to digital equipment meets its specifications. Specifically, the transition time from a low logic level (0.8 V) to a high logic level (2.0 V) must be 10 ns or less.

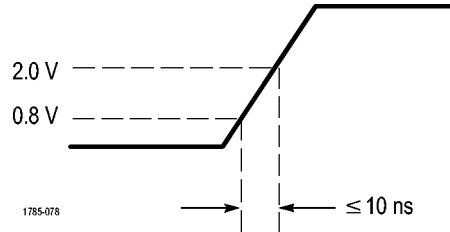

To select the Rise Time measurement:

1. Push **Measure**.



2. Push **Add Measurement**.

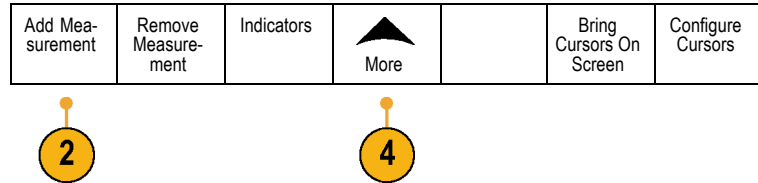

3. Turn multipurpose knob **a** to select the **Rise Time** measurement. If needed, press **Source** from the side menu and turn multipurpose knob **b** to select the channel from which you want to measure. Push **OK Add Measurement** from the side menu.



4. Push **More** repeatedly until you select **Reference Levels** from the popup menu.

5. Push **Set Levels in** to select **units**.

6. Push **High Ref** and turn multipurpose knob **a** to enter 2.00 V. If needed, push **Fine** to change the sensitivity of the multipurpose knob.

7. Push **Low Ref** and turn multipurpose knob **a** to enter 800 mV. If needed, push **Fine** to change the sensitivity of the multipurpose knob.

Reference Levels
Set Levels in %  Units
High Ref (a) 2.00 V
Mid Ref
Low Ref (a) 800 mV

Rise time is typically measured between the 10% and 90% amplitude levels of a signal. These are the default reference levels that the oscilloscope uses for rise time measurements. However, in this example, you need to measure the time that the signal takes to pass between the 0.8 V and 2.0 V levels.

You can customize the rise time measurement to measure the signal transition time between any two reference levels. You can set each of these reference levels to a specific percent of the signal amplitude or to a specific level in vertical units (such as volts or amperes).

**Measuring Specific Events.** Next you want to see the pulses in the incoming digital signal, but the pulse widths vary so it is hard to establish a stable trigger. To look at a snapshot of the digital signal, do this step:

1. Push **Single** to capture a single acquisition.  
This assumes that the oscilloscope will trigger with the current settings.



Now you want to measure the width of each displayed pulse. You can use measurement gating to select a specific pulse to measure. To measure the second pulse:

2. Push **Measure**.



3. Push **Add Measurement**.



4. Turn multipurpose knob **a** to select the **Positive Pulse Width** measurement. If needed, press **Source** from the side menu and turn multipurpose knob **b** to select the channel from which you want to measure. Push **OK Add Measurement** from the side menu.



2410-045

5. Push **More** repeatedly until you select **Gating** from the popup menu.

6. Select **Between Cursors** from the side-bezel menu to choose measurement gating using cursors.

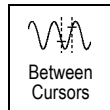

7. Place one cursor to the left and one cursor to the right of the second pulse.
8. View the resulting width measurement (160 ms) for the second pulse.

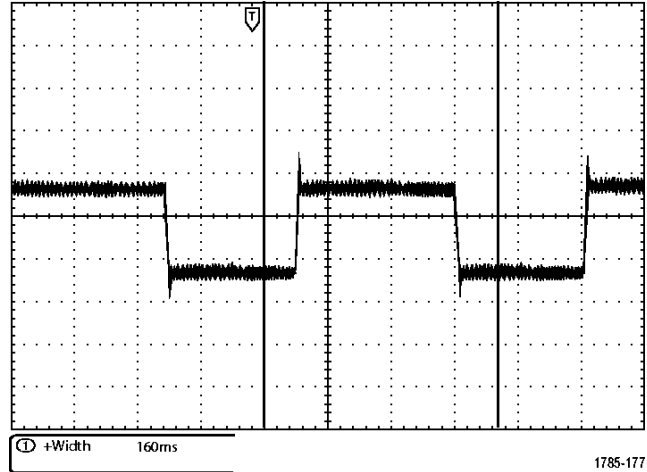

## Analyzing Signal Detail

In this example, you have a noisy signal displayed on the oscilloscope, and you need to know more about it. You suspect that the signal contains much more detail than you can currently see in the display.

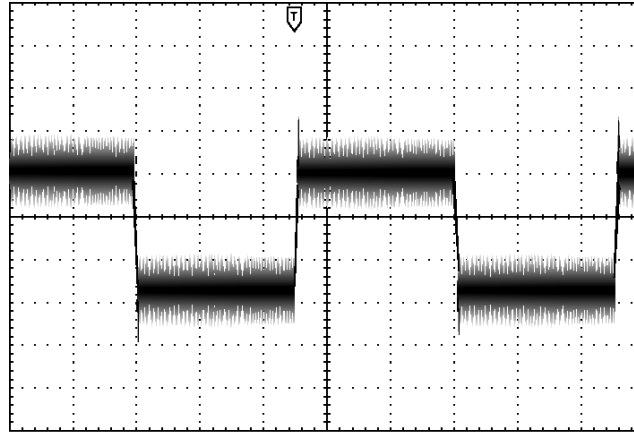

1785-175



## Looking at a Noisy Signal

The signal appears noisy. You suspect that noise is causing problems in your circuit. To better analyze the noise:

1. Push **Acquire**.



2. Push **Mode** on the lower-bezel menu.

Mode <b>Sample</b>	Record Length <b>10k</b>	Delay On <b>Off</b>	Set Horiz. Position to 10%	Waveform Display	XY Display <b>Off</b>	
-----------------------	-----------------------------	------------------------	----------------------------------	---------------------	--------------------------	--



3. Push **Peak Detect** on the side-bezel menu.

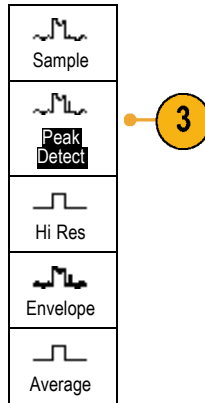

4. Push **Intensity** and turn multipurpose knob a to see the noise more easily.



5. View the results on the display. Peak detect emphasizes noise spikes and glitches in your signal as narrow as 1 ns, even when the time base is set to a slow setting.

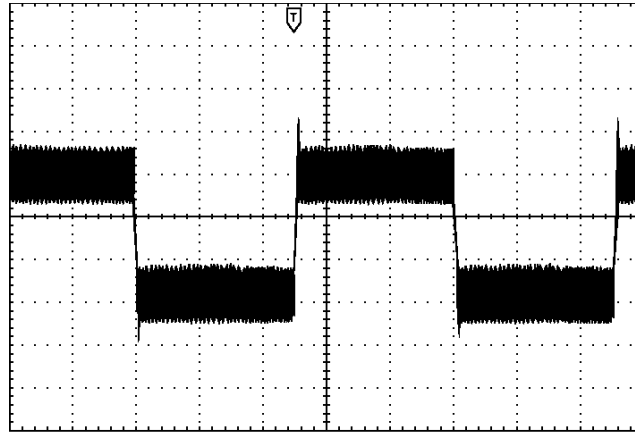

1785-174

Peak-detect and the other acquisition modes are explained earlier in this manual. (See page 85, *Acquisition Concepts*.)

## Separating the Signal from Noise

Now you want to analyze the signal shape and ignore the noise. To reduce random noise in the oscilloscope display:

1. Push **Acquire**.



2. Push **Mode**.

Mode <b>Sample</b>	Record Length <b>10K</b>	Delay On <b>Off</b>	Set Horiz. Position to 10%	Waveform Display	XY Display <b>Off</b>	
-----------------------	-----------------------------	------------------------	-------------------------------	------------------	--------------------------	--



3. Push **Average** on the side-bezel menu.



Averaging reduces random noise and makes it easier to see detail in a signal. In the example to the right, a ring shows on the rising and falling edges of the signal when the noise is removed.

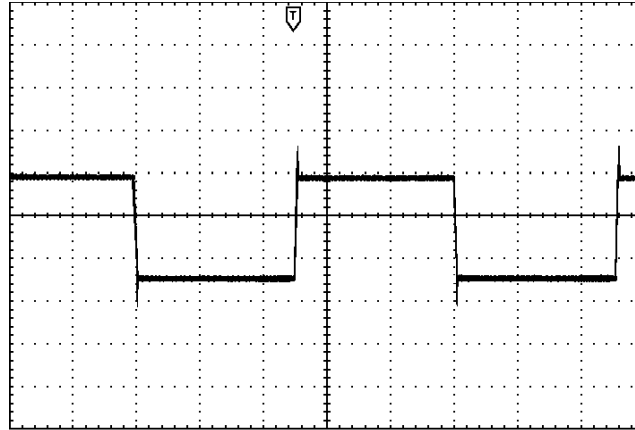

1785-176

## Taking Cursor Measurements

You can use the cursors to take quick measurements on a waveform. To measure the ring frequency at the rising edge of the signal:

1. Push channel 1 to select the channel 1 signal.



2. Push **Measure**.



3. Push **Configure Cursors**.

Add Measurement	Remove Measurement	Indicators	More		Bring Cursors On Screen	Configure Cursors
-----------------	--------------------	------------	------	--	-------------------------	-------------------



4. Push **Vertical Bar Units** from the side menu, if this choice is not already selected. Turn multipurpose knob **a** to select **Hz (1/s)** as the unit of measurement.



2410-045

5. Push **Cursors** repeatedly until the two vertical bar cursors appear on the selected waveform.



2410-056

6. Place one cursor on the first peak of the ring using multipurpose knob **a**.



2410-045

7. If the cursor readout says that the cursors are linked, push **Select** to unlink them.



8. Place the other cursor on the next peak of the ring using multipurpose knob **b**.





9. The cursor  $\Delta$  readout shows the measured ring frequency is 227 kHz.

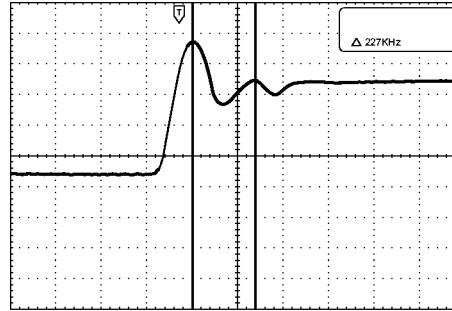

1785-169

## Triggering on a Video Signal

The oscilloscope supports triggering on NTSC, SECAM, and PAL signals.

In this example, you are testing the video circuit in a piece of medical equipment and need to display the video output signal. The video output is an NTSC standard signal. Use the video signal to obtain a stable display.

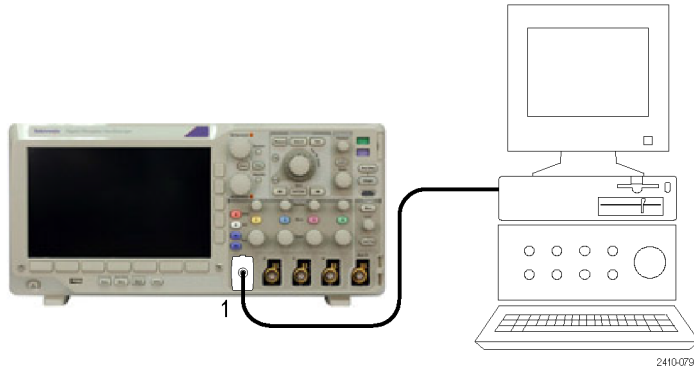

To trigger on the video fields:

1. Push Trigger **Menu**.



2. Push **Type**.

Type



3. Turn multipurpose knob **a** to scroll through the trigger type side menu until you select **Video**.

Video

4. Push **Video Standard**, and turn multipurpose knob **a** to scroll through the standards until you select **525/NTSC**.

Type <b>Video</b>	Video Standard <b>525/NTSC</b>	Source <b>1</b>	Trigger On <b>All Lines</b>			Mode <b>Auto</b> & Holdoff
----------------------	-----------------------------------	--------------------	--------------------------------	--	--	----------------------------------

5. Push **Trigger On**.



6. Select **Odd Fields**.



If the signal had been noninterlaced, you could choose to trigger on **All Fields**.

7. Turn the **Horizontal Scale** knob to see a complete field across the screen.

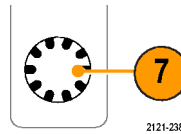

8. View results.

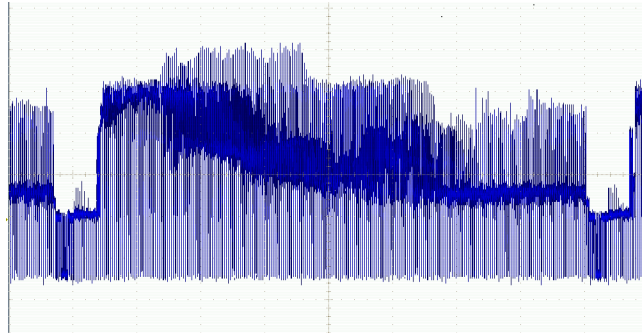

## Triggering on Lines

**Triggering on Lines.** To look at the video lines in the field:

1. Push **Trigger Menu**.



2. Push **Type**.

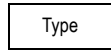

3. Turn multipurpose knob **a** to scroll through the trigger type side menu until you select **Video**.

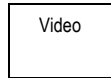

Type <b>Video</b>	Video Standard <b>525/NTSC</b>	Source <b>1</b>	Trigger On <b>All Lines</b>			Mode <b>Auto</b> & Holdoff
----------------------	-----------------------------------	--------------------	--------------------------------	--	--	----------------------------------

4. Push **Trigger On**.



5. Select **All Lines**.

To trigger on a specific line, select **Line Number**, and use multipurpose knob **a** to select the line number.

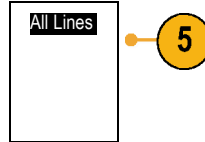

6. Adjust **Horizontal Scale** to see a complete video line across the screen.

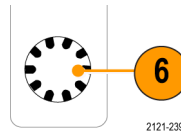

7. Observe the results.

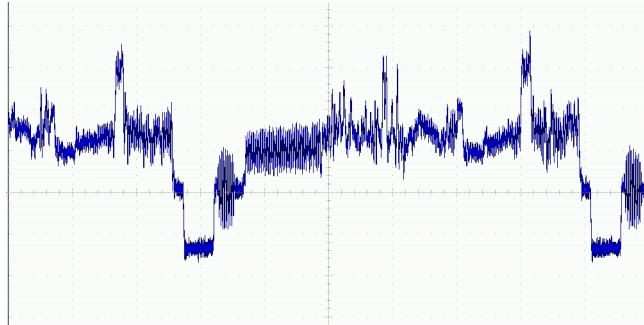

## Capturing a Single-Shot Signal

In this example, the reliability of a reed relay in a piece of equipment has been poor, and you need to investigate the problem. You suspect that the relay contacts arc when the relay opens. The fastest you can open and close the relay is about once per minute, so you need to capture the voltage across the relay as a single-shot acquisition.

To set up for a single-shot acquisition:

1. Adjust the **Vertical Scale** and **Horizontal Scale** to appropriate ranges for the signal you expect to see.

2. Push **Acquire**.



3. Push **Mode**.

4. Select **Sample**.

5. Push Trigger **Menu**.



6. Push **Slope** and .

7. Turn the **Trigger Level** knob to adjust the trigger level to a voltage midway between the open and closed voltages of the replay.



8. Push **Single** (single sequence).



When the relay opens, the oscilloscope triggers and captures the event.

The **Single** sequence button disables auto triggering so that only a valid triggered signal is acquired.

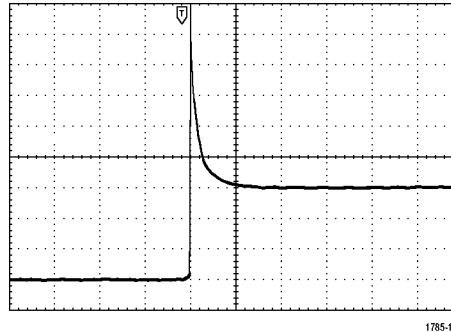

## Optimizing the Acquisition

The initial acquisition shows the relay contact beginning to open at the trigger point. This is followed by large spikes that indicate contact bounce and inductance in the circuit. The inductance can cause contact arcing and premature relay failure.

Before you take the next acquisition, you can adjust the vertical and horizontal controls to give you a preview of how the next acquisition might appear. As you adjust these controls, the current acquisition is repositioned, expanded, or compressed. This preview is useful to optimize the settings before the next single-shot event is captured.

When the next acquisition is captured with the new vertical and horizontal settings, you can see more detail about the relay contact opening. You can now see that the contact bounces several times as it opens.

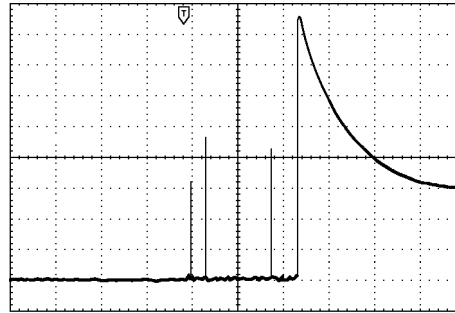

1785-173

## Using the Horizontal Zoom Function

To take a close look at a particular point on the acquired waveform, use the horizontal zoom function. To look closely at the point where the relay contact first begins to open:

1. Turn the **Zoom** knob.

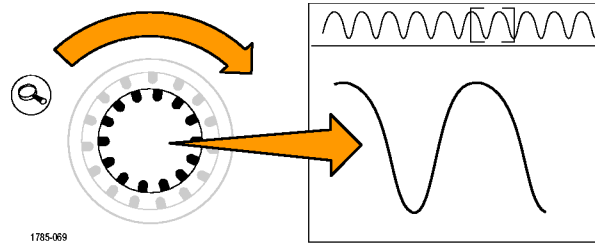

2. Turn the **Pan** knob to place the center of the zoom box close to where the relay contact begins to open.
3. Turn the **Zoom** knob to magnify the waveform in the zoom window.

The ragged waveform and the inductive load in the circuit suggest that the relay contact may be arcing as it opens.

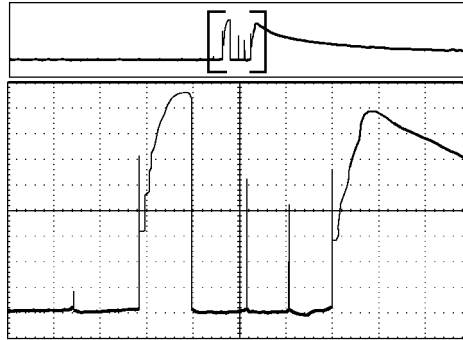

1785-173

## Correlating Data with a TLA5000 Logic Analyzer

To troubleshoot designs with fast clock edges and data rates, it helps to view analog characteristics of digital signals in relation to complex digital events in the circuit. You can do that with iView, which lets you transfer analog waveforms from the oscilloscope to the logic analyzer display. You can then view time-correlated analog and digital signals side-by-side, and use this to pinpoint sources of glitches and other problems.

The iView External Oscilloscope Cable allows you to connect your logic analyzer to a Tektronix oscilloscope. This enables communication between the two instruments. For DPO3000 series oscilloscopes, you also need a TEK-USB-488 adaptor. The Add External Oscilloscope wizard, which is available from the TLA application System menu, guides you through the process of connecting the iView cable between your logic analyzer and oscilloscope.

The TLA also provides a setup window to assist you in verifying, changing, and testing the oscilloscope settings. Before acquiring and displaying a waveform, you must establish a connection between your Tektronix logic analyzer and oscilloscope using the Add External Oscilloscope wizard.

To do this:

1. Select **Add iView External Oscilloscope** from the logic analyzer System menu.

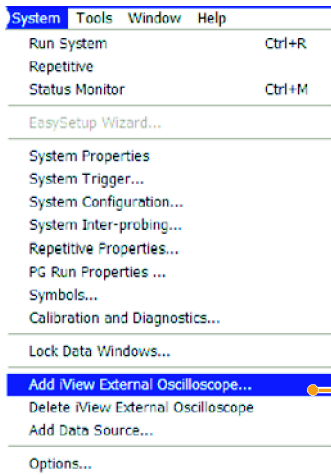

2. Select your model of oscilloscope.
3. Follow the on-screen instructions, and then click **Next**.
4. See your Tektronix Logic Analyzer documentation for more information on correlating data between your Tektronix oscilloscope and logic analyzer.

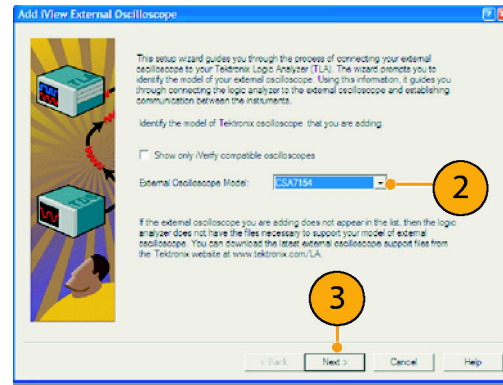

## Tracking Down Bus Anomalies

In this example, you are testing your new I<sup>2</sup>C circuit. Something is not working. You tell the master IC to send a message to the slave IC. Then you expect to receive data back and an LED to light. The light never goes on. Where in the ten or so commands that were sent out did the problem occur? Once you locate the problem location, how do you determine what went wrong?

You can use your oscilloscope, with its serial triggering and long-record length management features, to track down the problem in both the physical layer and in the protocol layer of the bus.

## Basic Strategy

First, you will display and acquire the bus signal by setting up the bus parameters and trigger. Then, you will search through each packet with the search/mark functions.

---

**NOTE.** *Triggering on I<sup>2</sup>C, SPI, CAN, LIN, RS-232, RS-422, RS-485, and UART bus signals requires use of an appropriate DPO3EMBD, DPO3AUTO, or DPO3COMP Serial Triggering and Analysis Module.*

---



1. Connect the channel 1 probe to the clock line.
2. Connect the channel 2 probe to the data line.

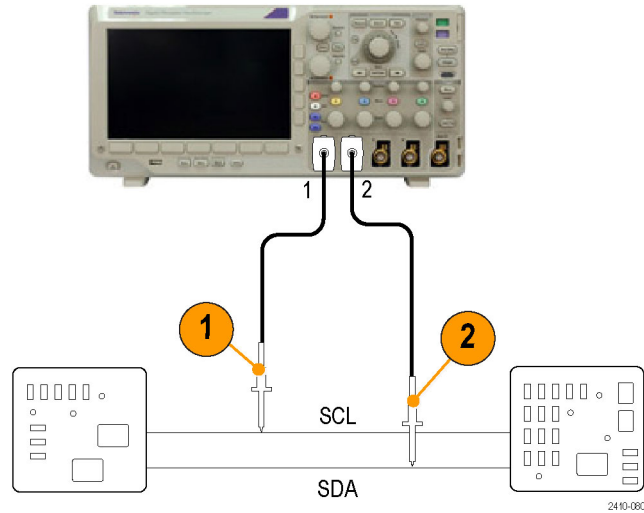

3. Push **Autoset**.



4. Push the **B1** button and enter the parameters of your I<sup>2</sup>C bus in the resulting screen menus.

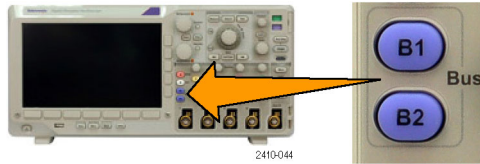

5. Push **Trigger Menu**.



6. Push **Type** to select **Bus**. Enter trigger parameters in the resulting screen menus.

Type <b>Bus</b>	Source Bus <b>B1 (I2C)</b>	Trigger On <b>Address</b>	Address <b>07F</b>		Direction <b>Read</b>	Mode <b>Auto</b> & Holdoff
--------------------	-------------------------------	------------------------------	-----------------------	--	--------------------------	----------------------------------



7. Analyze the physical layer. For example, you can use the cursors for manual measurements. (See page 171, *Taking Manual Measurements with Cursors*.) You can also use the automated measurements. (See page 155, *Taking Automatic Measurements*.)



8. Push **Search**. Set **Search Marks** to **On**. Enter a search type, source, and other parameters as relevant on the lower-bezel menu and associated side-bezel menus. (See page 189, *Using Wave Inspector to Manage Long Record Length Waveforms*.)



9. Jump ahead to the next search point by pushing the right arrow key. Push it again and again until you see all the events. Jump back with the left arrow key. Do you have all the packets that you expected to have? If not, at least you have narrowed your search down to the last packet sent.



10. Analyze the decoded packets in the protocol layer. Did you send the data bytes in the correct order? Did you use the correct address?

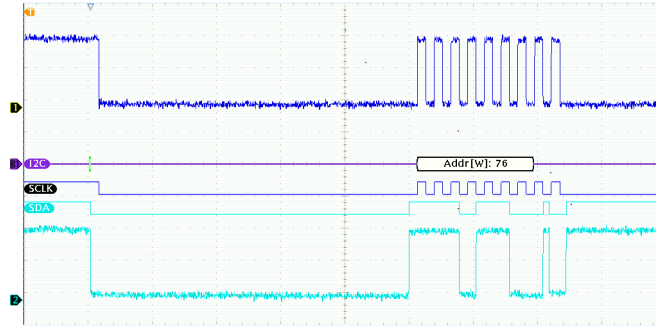

## Troubleshooting an RS-232 Bus

In this example, you are looking at analog characteristics of a digital signal in a digital circuit. You are doing this to analyze the signal integrity of a signal. For example, you might be testing RS-232 bus signals.

### Basic Strategy

First, you will display and acquire the digital signal. Then, you will look at both the analog and digital representations of the signal. Finally, you will search through each RS-232 byte with the search/mark functions.

---

**NOTE.** Triggering on RS-232 bus signals requires use of the DPO3COMP Serial Triggering and Analysis Module. (See page 24, Application Module Free Trial.)

---

1. Connect the desired analog probe tip to the desired test point.

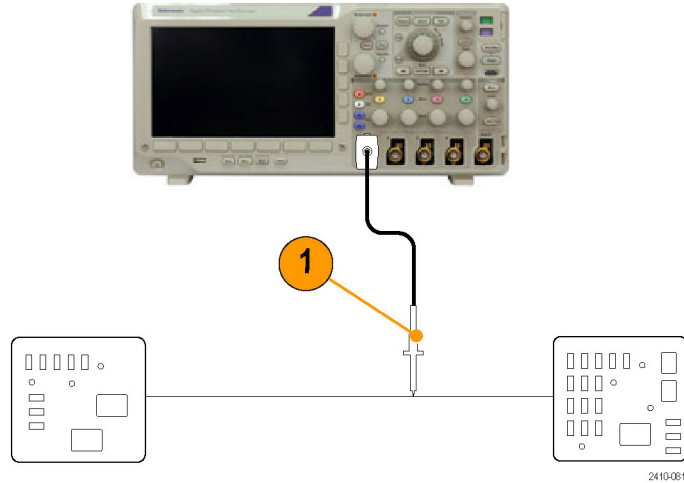

2. Push **Default Setup**.



3. Push **Autoset**.



4. Push **B1**.

5. Push the **Bus B1** lower-bezel button, use multipurpose knob **a** to select **RS-232**, and enter the parameters of the bus in the resulting screen menus.



6. Push the **Bus Display** lower-bezel button, push the **Bus and Waveforms** side-bezel button, and push the **ASCII** side-bezel.

7. Turn the Horizontal Scale knob to adjust the timebase.  
As you increase the time per division, you will see more data appear in the Bus display.
8. Push **Trigger Menu**. Select the **Bus** trigger type. Define what type of condition to trigger on, such as the Tx Start Bit.
9. Push **Search**, push the **Search** lower-bezel button, and select **On** in the side-bezel menu.
10. Push **Search Type**. Use multipurpose knob **a** to select **Bus**. Push **Search For** and select the desired search, such as for the Tx Start Bit.



11. Push the Previous and Next Mark buttons to navigate through the record.
12. Push Zoom and Pan to see the areas of interest and analyze the results.

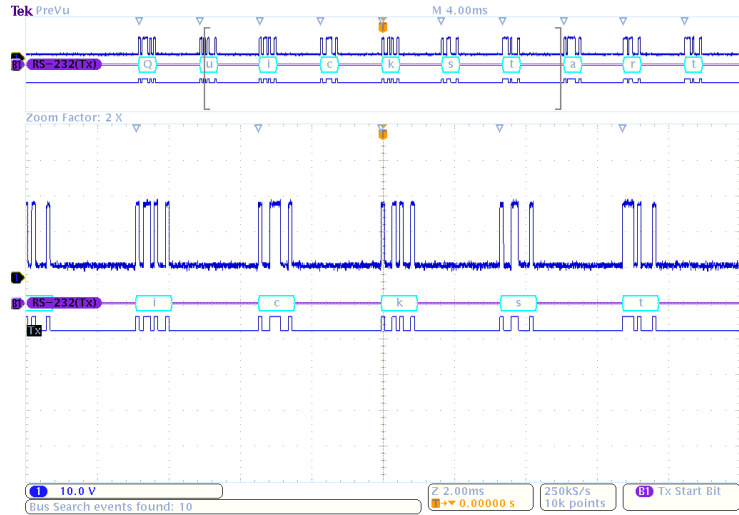



## Appendix: Warranted Specifications, Safety Certifications, and Electromagnetic Compatibility

Analog bandwidth, 50 $\Omega$	The limits stated below are for ambient temperature of $\leq 30$ °C and the bandwidth selection set to FULL. Reduce the upper bandwidth frequency by 1% for each °C above 30 °C.			
	Instrument	10 mV/div to 1 V/div	5 mV/div to 9.98 mV/div	
	DPO3054 and DPO3052	DC to 500 MHz	DC to 400 MHz	
	Instrument	2 mV/div to 4.98 mV/div	1 mV/div to 1.99 mV/div	
	DPO3054 and DPO3052	DC to 250 MHz	DC to 150 MHz	
	Instrument	5 mV/div to 1 V/div	2 mV to 4.98 mV/div	1 mV/div to 1.99 mV/div
	DPO3034 and DPO3032	DC to 300 MHz	DC to 250 MHz	DC to 150 MHz
	Instrument	1 mV/div to 1 V/div		
	DPO3014 and DPO3012	DC to 100 MHz		

Input impedance, DC coupled	<p>1 M<math>\Omega</math> <math>\pm</math>1% in parallel with 11.5 pF <math>\pm</math>2 pF</p> <p>75 <math>\Omega</math> <math>\pm</math>1%</p> <p>VSWR <math>\leq</math> 1.3:1 from DC to 60 MHz, typical</p> <p>50 <math>\Omega</math> <math>\pm</math>1%</p> <p>DPO3054, DPO3052: VSWR <math>\leq</math> 1.5:1 from DC to 500 MHz, typical</p> <p>DPO3034, DPO3032: VSWR <math>\leq</math> 1.5:1 from DC to 350 MHz, typical</p> <p>DPO3014, DPO3012: VSWR <math>\leq</math> 1.5:1 from DC to 100 MHz, typical</p>
DC Balance	<p>0.2 div with the input DC-50 <math>\Omega</math> coupled and 50 <math>\Omega</math> terminated</p> <p>0.2 div with the input DC-75 <math>\Omega</math> coupled and 75 <math>\Omega</math> terminated</p> <p>0.25 div at 2 mV/div with the input DC-50 <math>\Omega</math> coupled and 50 <math>\Omega</math> terminated</p> <p>0.25 div at 2 mV/div with the input DC-75 <math>\Omega</math> coupled and 75 <math>\Omega</math> terminated</p> <p>0.5 div at 1 mV/div with the input DC-50 <math>\Omega</math> coupled and 50 <math>\Omega</math> terminated</p> <p>0.5 div at 1 mV/div with the input DC-75 <math>\Omega</math> coupled and 75 <math>\Omega</math> terminated</p> <p>0.2 div with the input DC-1 M<math>\Omega</math> coupled and 50 <math>\Omega</math> terminated</p> <p>0.3 div at 1 mV/div with the input DC-1 M<math>\Omega</math> coupled and 50 <math>\Omega</math> terminated</p>
DC Gain accuracy	<p><math>\pm</math>2.5% for Coarse setting of 1 mV/div, derated at 0.100%/°C above 30 °C</p> <p><math>\pm</math>2.0% for Coarse setting of 2 mV/div, derated at 0.100%/°C above 30 °C</p> <p><math>\pm</math>1.5% for Coarse settings of 5 mV/div and above, derated at 0.100%/°C above 30 °C</p> <p><math>\pm</math>3.0% for all Fine V/div settings, derated at 0.100%/°C above 30 °C</p>

Offset accuracy	$\pm[0.005 \times   \text{offset} - \text{position}   + \text{DC Balance}]$  <i><b>NOTE.</b> Both the position and constant offset term must be converted to volts by multiplying by the appropriate volts/div term.</i>						
Long-term sample rate and delay time accuracy	$\pm 10$ ppm over any $\geq 1$ ms time interval						
Auxiliary output (AUX OUT)	LOW TRUE; LOW to HIGH transition indicates that the trigger occurred. The logic levels are given in the following table:						
	<table border="1"> <thead> <tr> <th>Characteristic</th> <th>Limits</th> </tr> </thead> <tbody> <tr> <td>Vout (HI)</td> <td><math>\geq 2.5</math> V open circuit; <math>\geq 1.0</math> V into a 50 <math>\Omega</math> load to ground</td> </tr> <tr> <td>Vout (LO)</td> <td><math>\leq 0.7</math> V into a load of <math>\leq 4</math> mA; <math>\leq 0.25</math> V into a 50 <math>\Omega</math> load to ground</td> </tr> </tbody> </table>	Characteristic	Limits	Vout (HI)	$\geq 2.5$ V open circuit; $\geq 1.0$ V into a 50 $\Omega$ load to ground	Vout (LO)	$\leq 0.7$ V into a load of $\leq 4$ mA; $\leq 0.25$ V into a 50 $\Omega$ load to ground
Characteristic	Limits						
Vout (HI)	$\geq 2.5$ V open circuit; $\geq 1.0$ V into a 50 $\Omega$ load to ground						
Vout (LO)	$\leq 0.7$ V into a load of $\leq 4$ mA; $\leq 0.25$ V into a 50 $\Omega$ load to ground						
Safety Certification	<p><b>U.S. Nationally Recognized Testing Laboratory (NRTL) Listing:</b> UL61010–1–2004 Standard for Electrical Measuring</p> <p><b>Canadian Certification:</b> CAN/CSA C22.2 No. 61010–1 2004 Safety Requirements for Electrical Equipment for Measurement, Control, and Laboratory Use</p> <p><b>European Union Compliance:</b> Low Voltage Directive 2006/95/EC, as Amended by 93/68/EEC EN61010–1 2001 Safety Requirements for Electrical Equipment for Measurement, Control, and Laboratory Use</p> <p><b>Additional Compliance:</b> IEC61010–1 2001 Safety Requirements for Electrical Equipment for Measurement, Control, and Laboratory Use</p>						

---

Electromagnetic Compatibility (EMC)

---

European Union	EC Council EMC Directive 89/336/EEC, amended by 93/68/EEC; Demonstrated using: IEC 61326:1997 Product Family Standard for Electrical Equipment for Measurement, Control, and Laboratory Use-EMC Requirements Emissions: EN 55011, Class A IEC 61000-3-2 IEC 61000-3-3 Immunity IEC 61000-4-2 IEC 61000-4-3 IEC 61000-4-4 IEC 61000-4-5 IEC 61000-4-6 IEC 61000-4-8 IEC 61000-4-11
Australia	EMC Framework, demonstrated per Emission Standard AS/NZS 2064 (Industrial, Scientific, and Medical Equipment)

---

# Index

## Symbols and Numbers

50  $\Omega$  protection, 151

## A

About, 39

Accessories, 1

Acquire button, 54, 90, 136, 241, 244

Acquisition

input channels and digitizers, 85

modes defined, 88

readout, 65

sampling, 86

Adapter

TEK-USB-488, 6

TPA-BNC, 5, 13

Adding waveform, 136

Advanced math, 184

Altitude

DPO3000, 9

P6139A, 11

Amplitude measurement, 160

Annotating the screen, 153

Application modules, 25, 226

30-day free trial, 24

DPO3AUTO, 5, 95

DPO3COMP, 5, 95

DPO3EMBD, 5, 95

DPO3VID, 5, 120

Area measurement, 162

Attenuation, 150

Auto trigger mode, 108

Autoset, 84, 228

Video, 85

Autoset button, 21, 54, 61, 77, 84, 228

Autoset undo, 85

Aux In connector, 72

Aux Out connector, 74

Auxiliary readout, 70

Average acquisition mode, 89

## B

B trigger, 134

B1 / B2 button, 95, 96, 121

Backlight intensity, 142

Bandwidth, x, 148

Before Installation, 1

Blackman-Harris FFT window, 184

BNC interface, 14

Burst Width measurement, 158

Bus

button, 95, 96, 121

display, 71, 102, 103

menu, 56, 97

positioning and labeling, 151

setup, 96

Bus and Waveforms display, 102

show physical layer bus

activity, 105

Bus trigger, defined, 120

Buses, 95, 121

cursor readout, 176

Button

Acquire, 54, 90, 136, 241, 244

Autoset, 21, 54, 61, 77, 84, 228

B1 / B2, 56, 95, 96, 121

bus, 95, 96, 121

Cal, 74

Channel, 55

Cursors, 57, 171, 247

Default Setup, 63, 77, 83

Fine, 53, 57, 58, 59, 60, 62

- Force Trig, 61, 109
- hard copy, 62, 222
- Intensity, 143
- M, 56, 178, 180
- Math, 56, 178, 180
- Measure, 54, 155, 165, 166,  
229, 232, 235, 237
- Menu Off, 63, 230
- Next, 60
- Play-pause, 59, 193
- Previous, 60
- Print, 62
- printer, 222
- Ref, 56, 187, 207
- Run/Stop, 61, 94, 135
- Save / Recall, 55, 63, 203
- Search, 54, 196
- Select, 58, 248
- Set / Clear Mark, 60, 195
- Set to 50%, 61, 113
- Single, 61, 135, 237, 257
- Test, 54
- Trigger, 54
- Trigger level, 61
- Trigger menu, 114, 250
- Utility, 26, 28, 31, 55, 139, 142,  
153, 214

- Vertical, 55
- Zoom, 59
- byte matching, 129

## C

- Cal button, 74
- Calibration, 30, 32
- Calibration certificate, 2
- CAN, 56, 95, 121
- CAN trigger, 127
- Channel button, 55
- Channel readout, 70
- Channel vertical menu, 147
- Cleaning, 12
- Clearance, DPO3000, 8
- Communications, 40, 45
- Compensate probe, 22
- Compensate signal path, 30
- Confidential data, 223
- Connecting a USB keyboard, 48
- Connecting to a PC, 40
- Connectivity, 2, 40, 45
- Connector
  - Aux Out, 74
  - Probe Power, 74
  - Video port, 74

## Connectors

- front-panel, 72
- rear-panel, 74
- side-panel, 73

## Controls, 49

## Coupling, 147

## Coupling, trigger, 110

## Cover, front, 3

## Cross Hair graticule style, 141

## CSV format, 206

## Cursor readout, 67, 176

## Cursors, 171

- button, 57, 171, 247
- linking, 172
- measurements, 171
- menu, 171
- XY, 177

## Cycle Area measurement, 162

## Cycle Mean measurement, 161

## Cycle RMS measurement, 161

## D

## Date and time, changing, 28

## Default Setup, 83, 211

- button, 63, 77, 83
- menu, 63

- Undo, 84
- Delay measurement, 157
- Delay time, 92, 93
- Delayed trigger, 131
- Depth, DPO3000, 8
- Deskew, 150
- Display
  - information, 64
  - persistence, 136
  - style, 136
  - XY, 138, 139
- Displaying, reference waveforms, 207
- DPO3AUTO, 5, 95, 226
- DPO3COMP, 5, 95, 226
- DPO3EMBD, 5, 95, 226
- DPO3VID, 5, 120, 226
- Drivers, 40, 44
- Dual waveform math, 178

## E

- e\*Scope, 45
- Edge trigger, defined, 116
- Envelope acquisition mode, 89
- Erase setup and ref memory, 223
- Ethernet, xi, 43, 45, 46
  - port, 74

- printing, 217
- Event Table, 103, 104
- Excel, 40
- Expansion point, 88
- Expansion point icon, 66

## F

- Factory calibration, 32
- Fall Time measurement, 157
- Falling Edge Count measurement, 162
- FFT
  - Blackman-Harris, 184
  - controls, 180
  - Hamming, 183
  - Hanning, 183
  - Rectangular, 183
- File format, 203
  - Internal File Format (ISF), 206
  - Spreadsheet file format (.CSV), 206
- File names, 199
- File system, 199, 206
- Fine, 58
- Fine button, 53, 57, 59, 60, 62
- Firmware upgrade, 33

- Firmware version, 39
- firmware.img file, 33
- Force Trig button, 61, 109
- Frame graticule style, 141
- Frequency measurement, 157
- Frequency, Source
  - DPO3000, 8
- Front cover, 3
- Front panel, 49
- Front-panel connectors, 72
- Front-panel overlay, 27
- Full graticule style, 141
- Functional check, 19

## G

- Gating, 163
- GPIO, 41, 75
- GPIO address, 43
- Graticule
  - Cross Hair, 141
  - Frame, 141
  - Full, 141
  - Grid, 141
  - intensity, 143
  - IRE, 141
  - mV, 141

- styles, 139
- Grid graticule style, 141
- Ground, 16
- Ground lead, 24
- Ground strap, 16
- Ground strap connector, 73
- Ground yourself to discharge static, 16

## H

- Hamming FFT window, 183
- Hanning FFT window, 183
- Hard copy, 214
- Hard copy button, 62
- Height, DPO3000, 8
- Hi Res acquisition mode, 89
- High measurement, 160
- Holdoff, trigger, 109
- Horizontal delay, 110
- Horizontal position, 60, 88, 110, 111, 144, 182, 259
  - and math waveforms, 179
  - defined, 78
  - readout, 69
- Horizontal scale, 60, 144, 182, 252, 254, 255, 259
  - and math waveforms, 179

- defined, 78
- readout, 69
- How to
  - compensate a voltage probe, 22
  - compensate the signal path, 30
  - connect probes and adapters, 13
  - connect to a computer, 40
  - erase memory, 223
  - label channels and buses, 79
  - manage long record length waveforms, 189
  - perform a functional check, 19
  - power off the oscilloscope, 18
  - power on the oscilloscope, 16
  - print a hard copy, 214
  - recall setups, 209
  - recall waveforms, 203
  - save screen images, 203
  - save setups, 209
  - save waveforms, 203
  - search through and add marks to waveforms, 194
  - select a trigger, 116
  - select automatic measurements, 157
  - setup analog channels, 76
  - setup bus parameters, 96

- setup input parameters, 146
- setup VISA communications, 40
- take automatic measurements, 155
- take manual measurements with cursors, 171
- trigger on buses, 121
- upgrade the firmware, 33
- use a sequential trigger, 131
- use e\*Scope, 45
- use Wave Inspector, 189

## Humidity

- DPO3000, 9
- P6139A, 12

## I

- I2C, 56, 95, 121
- trigger, 124

## Icon

- Expansion point, 66
- Trigger level, 68
- Trigger position, 66

- Image orientation, 204, 216

- Impedance, 148

- Indicator, waveform baseline, 71

- Infinite persistence, 139



Ink Saver, 204, 216  
Inner knob, 59, 179  
Intensity button, 143  
Internal File Format (ISF), 206  
Invert, 148  
IRE graticule, 141  
ISF format, 206

## K

Keyboard, USB, 48  
Knob  
    inner, 59, 179  
    Multipurpose, 29, 53, 58, 59, 90,  
        206, 247, 248  
    outer, 59  
    pan, 59, 192, 195  
    Trigger level, 113  
    Vertical menu, 62  
    Vertical position, 62, 78  
    Vertical scale, 62, 78  
    zoom, 59, 179, 190

## L

Label bus, 151  
LabView, 40  
LAN port, 74

Landscape, 204, 216  
Language  
    change, 26  
    overlay, 27  
Level, trigger, 112  
LIN, 56, 95, 121  
    trigger, 128  
Lock, standard laptop, 15  
Logic trigger, defined, 118  
Long record length, 263  
    management, 189  
Low measurement, 160

## M

M button, 56, 178, 180  
Main trigger, 131  
Mark, 194  
Math  
    Advanced, 184  
    button, 56, 178, 180  
    Dual waveform, 178  
    FFT, 180  
    menu, 56  
    waveforms, 177  
Max measurement, 160  
Mean measurement, 161

Measure button, 54, 155, 165, 166,  
    229, 232, 235, 237  
Measurement menu, 54  
Measurements  
    automatic, 155  
    cursor, 171  
    defined, 157  
    reference levels, 169  
    snapshot, 166  
    statistics, 165  
Memory, erasure of, 223  
Menu, 49  
    Bus, 56, 97  
    buttons, 53  
    Cursors, 171  
    Default Setup, 63  
    Math, 56  
    Measurement, 54  
    Reference, 56, 187, 188  
    Save / Recall, 55, 63, 203  
    Trigger, 54, 114, 131, 250  
    Utility, 26, 28, 55, 62, 139, 153,  
        215  
    Vertical, 55, 146  
Menu Off button, 63, 230  
Min measurement, 160  
Mode, roll, 93

Multipurpose knob, 53, 58, 59, 90,  
206, 247, 248

mV graticule, 141

## N

Negative Duty Cycle measure-  
ment, 158

Negative Overshoot measure-  
ment, 159

Negative Pulse Count  
measurement, 162

Negative Pulse Width  
measurement, 158

Network printing, 217

Next button, 60

NI SignalExpress Tektronix Edition  
software, xi

Normal trigger mode, 108

## O

Offset and position, 150

Offset vertical, 149

OpenChoice, xi, 2

Operating specifications, 8

Orientation of the image, 204, 216

Outer knob, 59

Overlay, 27

## P

P6139A probe, 3

Pan, 190, 191  
knob, 59, 192, 195

Parallel bus, 121

Pause, 191

Peak detect acquisition mode, 89

Period measurement, 157

Persistence

display, 136

infinite, 139

variable, 139

Phase measurement, 158

Physical layer bus activity, 105

Pk-Pk measurement, 160

Play, 191

Play-pause button, 59, 193

Play-pause mode, 193

Pollution Degree

DPO3000, 9

P6139A, 11

Portrait, 204, 216

Position

bus, 151

Horizontal, 110, 111, 144, 182,  
259

Vertical, 145

Position and offset, 150

Positive Duty Cycle measure-  
ment, 157

Positive Overshoot measurement, 159

Positive Pulse Count  
measurement, 162

Positive Pulse Width  
measurement, 158

Posttrigger, 107, 111

Power

cord, 4

input, 75

off, 18

removing, 18

supply, 16

switch, 62

Power consumption, DPO3000, 8

Predefined math expressions, 178

Pretrigger, 107, 111

Previous button, 60

Print, 215

Ethernet, 217

hard copy, 214

Print button, 62

Probe Comp, 20  
 PROBE COMP connector, 72  
 Probe compensation, 22  
 Probe connector  
   analog, 72  
 Probe Power connector, 74  
 Probes  
   BNC, 14  
   connecting, 13  
   ground lead, 24  
   P6139A, 3  
   TEK-USB-488 Adapter, 6  
   TekVPI, 13  
   TPA-BNC Adapter, 5, 13  
 Pulse Width trigger, defined, 117

## R

Rackmount, 6  
 Readout  
   Acquisition, 65  
   Auxiliary, 70  
   Bus Display, 102  
   Channel, 70  
   Cursor, 67, 176  
   Horizontal position/scale, 69  
   Record length/sampling rate, 68  
   Trigger, 68, 130  
   Trigger status, 67  
 Real-time sampling, 86  
 Rear-panel connectors, 74  
 Recalling  
   setups, 209  
   waveforms, 203  
 Record length, x, 87  
 Record length/sampling rate  
   readout, 68  
 Rectangular FFT window, 183  
 Ref button, 56, 187, 207  
 Ref R, 207  
 Reference levels, 169  
 Reference menu, 56, 187, 188  
 Reference waveforms, 187  
   displaying, 207  
   removing, 188, 208  
   saving, 206  
   saving 5 M waveforms, 188  
 Removing reference waveforms, 188, 208  
 Removing waveform, 136  
 Rise Time measurement, 157  
 Rise/Fall trigger, defined, 119  
 Rising Edge Count measurement, 162  
 RMS measurement, 161

Roll mode, 93, 94  
 Rolling window data matching, 128  
 RS-232, 56, 95, 121  
   bus example, 268  
   byte matching, 129  
   cursor readout, 176  
   decoding, 106  
   trigger, 128  
 Run/Stop button, 61, 94, 135  
 Runt trigger, defined, 118

## S

Safety Summary, v  
 Sample acquisition mode, 88  
 Sample interval, 87  
 Sample rates, x  
 Sampling process, defined, 86  
 Sampling, real-time, 86  
 Save / Recall menu, 55, 63, 203  
 Save / Recall Menu button, 55  
 Save / Recall Save button, 63, 203  
 Saving  
   reference waveforms, 206  
   screen images, 203  
   setups, 209  
   waveforms, 203

- Saving and recalling Information, 199
- Scale
  - Horizontal, 60, 144, 182, 252, 254, 255, 259
  - Vertical, 145, 255
- Screen annotations, 153
- Search, 194
- Search / Mark, 263
- Search button, 54, 196
- Securing memory, 223
- Security lock, 15
- Select button, 58, 248
- Sequence (B Trigger), defined, 117
- Sequential triggering, 131
- Serial bus, 95, 263
- Serial bus trigger, 121
- Serial buses trigger, 123
- Set / Clear Mark button, 60, 195
- Set to 50% button, 61, 113
- Setup
  - default, 63, 77, 83, 211
- Setup and Hold trigger, defined, 119
- Side panel connector, 73
- Signal path compensation, 30
- Single button, 61, 135, 237, 257
- Single sequence, 94, 135
- Slope, trigger, 112

- Snapshot, 166
- Software drivers, 40, 44
- Software, optional, 226
- SPC, 30
- Specifications
  - operating, 8
  - power supply, 16
- SPI, 56, 95, 121
- SPI trigger, 126
- Spreadsheet file format (.CSV), 206
- Start an acquisition, 135
- Statistics, 165
- Stop an acquisition, 135
- SVGA Out, 74
- Switch, power, 62

## T

- Table, Event, 103, 104
- TEK-USB-488 Adapter, 6, 41, 43, 75
- TekSecure, 223
- TekVPI, 13
- Temperature
  - DPO3000, 8
  - P6139A, 11
- Termination, 148
- Test button, 54

- TPA-BNC Adapter, 5, 13
- Transit case, 6
- Transition trigger, defined, 119
- Trigger
  - B trigger after delay time, 133
  - Bus, defined, 120
  - buses, 121
  - byte matching, 129
  - CAN bus, 127
  - concepts, 107
  - coupling, 110
  - data matching on a rolling window, 128
  - delayed, 131
  - Edge, defined, 116
  - event, defined, 107
  - forcing, 108
  - holdoff, 109
  - I2C bus, 124
  - level, 112
  - level button, 61
  - level icon, 68
  - level knob, 113
  - LIN bus, 128
  - Logic, defined, 118
  - modes, 108, 115
  - point, 87

- position icon, 66
- posttrigger, 107, 111
- pretrigger, 107, 111
- Pulse Width, defined, 117
- readout, 68, 130
- Rise/Fall, defined, 119
- RS-232 bus, 128
- RS-232 byte matching, 129
- Runt, defined, 118
- Sequence (B Trigger),
  - defined, 117
- sequential, 131
- serial buses, 95, 123, 263
- Setup and Hold, defined, 119
- slope, 112
- SPI bus, 126
- status readout, 67
- Trigger on B events, 134
- video lines, 253
- Video, defined, 120
- Trigger menu, 54, 114, 131, 250
  - button, 114, 250
- Trigger modes
  - Auto, 108
  - Normal, 108
- Trigger types, defined, 116
- Triggering on Buses, 121

## U

- Undo
  - Autoset, 85
  - Default Setup, 84
- Upgrading firmware, 33
- USB, x, xi, 6, 41, 42, 44, 55, 199, 214
  - device port, 75
  - host ports, 63, 75
  - keyboard, 48
- USBTMC, 75
- User marks, 194
- Utility button, 26, 28, 31, 55, 139, 142, 153, 214
- Utility menu, 26, 28, 55, 62, 139, 153

## V

- Variable persistence, 139
- Versatile Probe Interface, 13
- Version, firmware, 39
- Vertical
  - button, 55
  - menu, 55, 146
  - Menu knob, 62
  - offset, 151
  - Offset, 149
  - position, 145

- position and autoset, 85
- position and offset, 150
- Position knob, 62, 78
- scale, 145, 255
- Scale knob, 62, 78
- Vibration, DPO3000, 9
- Video
  - Autoset, 85
  - fields, 250
  - lines, 253
  - port, 74
  - projector, 74
  - trigger, 249
- Video trigger, defined, 120
- View
  - waveform record, 66
- VISA, 40
- Voltage, Input
  - P6139A, 11
- Voltage, Output, P6139A, 11
- Voltage, Source
  - DPO3000, 8

## W

- Wave Inspector, x, 189
- Waveform

- adding, 136
- display style, 136
- intensity, 143
- pan, 190, 191
- pause, 191
- play, 191
- play-pause, 193
- record defined, 87
- removing, 136
- search and mark, 194
- user marks, 194
- zoom, 190

- Waveform baseline indicator, 71
- Waveform record, 87
- Waveform record view, 66
- Weight
  - DPO3000, 8
- Width
  - DPO3000, 8

## X

- XY
  - cursors, 177

- display, 138, 139

## Z

- Zoom, 190
  - button, 59
  - graticule size, 192
  - Horizontal, 259
  - knob, 59, 190